



French Report to **COSPAR** 2022

44th Scientific Assembly
16-24 July 2022
Athens, Greece

44th Scientific Assembly
16-24 July 2022
Athens, Greece

French Report to
COSPAR
2022

WORLD COMMITTEE FOR SPACE RESEARCH



CONTENTS



1. Space Studies of the Earth’s Surface, Meteorology and Climate	8
/ VENUS	10
// TRISHNA	14
/// IASI	16
//// CALIPSO	18
///// CFOSAT	20
///// SWOT	22
///// DATA CLUSTERS	26
2. Space Studies of the Earth-Moon System, Planets, and Small Bodies of the Solar System	28
/ INSIGHT	32
// DORN on CHANG’E 6	34
/// EXOMARS	36
3. Space Studies of the Upper Atmospheres of the Earth and Planets Including Reference Atmospheres	40
4. Space Plasmas in the Solar System, Including Planetary Magnetospheres	46
/ SOLAR ORBITER	49
// PARKER SOLAR PROBE	50
5. Research in Astrophysics from Space	52
/ GAIA	55
// EUCLID	56
/// ATHENA	58
//// SVOM	60
6. Life Sciences as Related to Space	62
/ BEDREST	64
7. Materials Sciences in Space	68
/ FLUIDICS	69
// DECLIC	72
8. Fundamental Physics in Space	74
/ LISA	76

Editorial

This report sets out CNES highlights in space science, particularly for Earth observation, universe science, condensed matter and life sciences in microgravity. Since the last edition of the CNES report to COSPAR, in 2018, important events have marked our agency's life and our lives. The task of summarizing CNES's achievements in space-based Earth and planetary science, and in astrophysics is a daunting one, as there is a vast amount of information. Nevertheless, let us note that the most remarkable event is the agency's 60th anniversary, in December 2021. In 60 years, CNES has acquired a level of technical know-how that it continues to cultivate today, to derive maximum benefit from space solutions for science and society.

During these four years, space—like all other sectors—was obviously hit by the COVID-19 pandemic. Space and time are fundamentals of space science, as well as of our own existence, and have been dramatically affected. Consider our experiences of space: our mobility has become severely restricted, as we have been reduced to jogging or walking a few kilometres around our homes. Perhaps less obviously, the lockdown has also affected our perception of time, the most important feature being a feeling of being stuck in the present, combined with the inability to plan ahead. In the midst of this crisis, it was hard to imagine a future different from the present. In particular, we have had to consider options for preserving the lines of communication with our colleagues and collaborators in the absence of face-to-face meetings, and to seek out effective online equivalents.

Nevertheless, over the last four years CNES has moved on and maintained its partnerships. An important rendezvous for the space science community was the Science Survey Seminar in Le Havre, in October 2019. Responsible for leading space science research in France, CNES organizes this seminar every five years to enable the scientific community to meet and shape French space science programmes. This forward-looking event is fundamental, because

it allows us to project ourselves beyond the horizon of current projects. The Science Survey Seminar identifies priorities for future programme decisions, relating to projects whose development will extend over the next ten years and scientific exploitation of their data well beyond. The task of CNES and its partners is to conduct multi-parametric analysis, combining science priorities with the various challenges of technical and industrial policy, cooperation

and sustainability in terms of human and financial resources. This report presents some of the latest achievements, and here we would like to underline a few.

Earth is under the constant watch of satellites taking its pulse and allowing us to anticipate its likely evolution. A few milestones over the last four years can be noted. In October 2018, CFOSat, the first French-Chinese scientific satellite, was launched. This mission is dedicated to measuring wind and waves over all the oceans and these new observations are accessible to the entire scientific community for the study of the ocean surface. The Space Climate Observatory (SCO) was officially launched by President Emmanuel Macron in June 2019 at the Paris Air Show. At national scale, the SCO offers a real opportunity to federate research efforts in different disciplines and chart a common course leveraging shared resources. By the middle of this year, the 36 SCO members will be enshrining their commitments to tackling climate change when they sign the International SCO Charter, which they have drafted together under the auspices of UNOOSA. Another notable event—started almost 30 years ago, when CNES and NASA took up the challenge of measuring mean sea level with great precision by launching the TOPEX/Poseidon, Jason-1, Jason-2 and Jason-3 missions—was CNES's decision to provide assistance to the operational agencies to prolong the time series of data beyond Jason-3. Copernicus Sentinel-6, launched in 2020, is the next radar altimetry reference mission to extend the record of sea-surface height measurements until at least 2030.

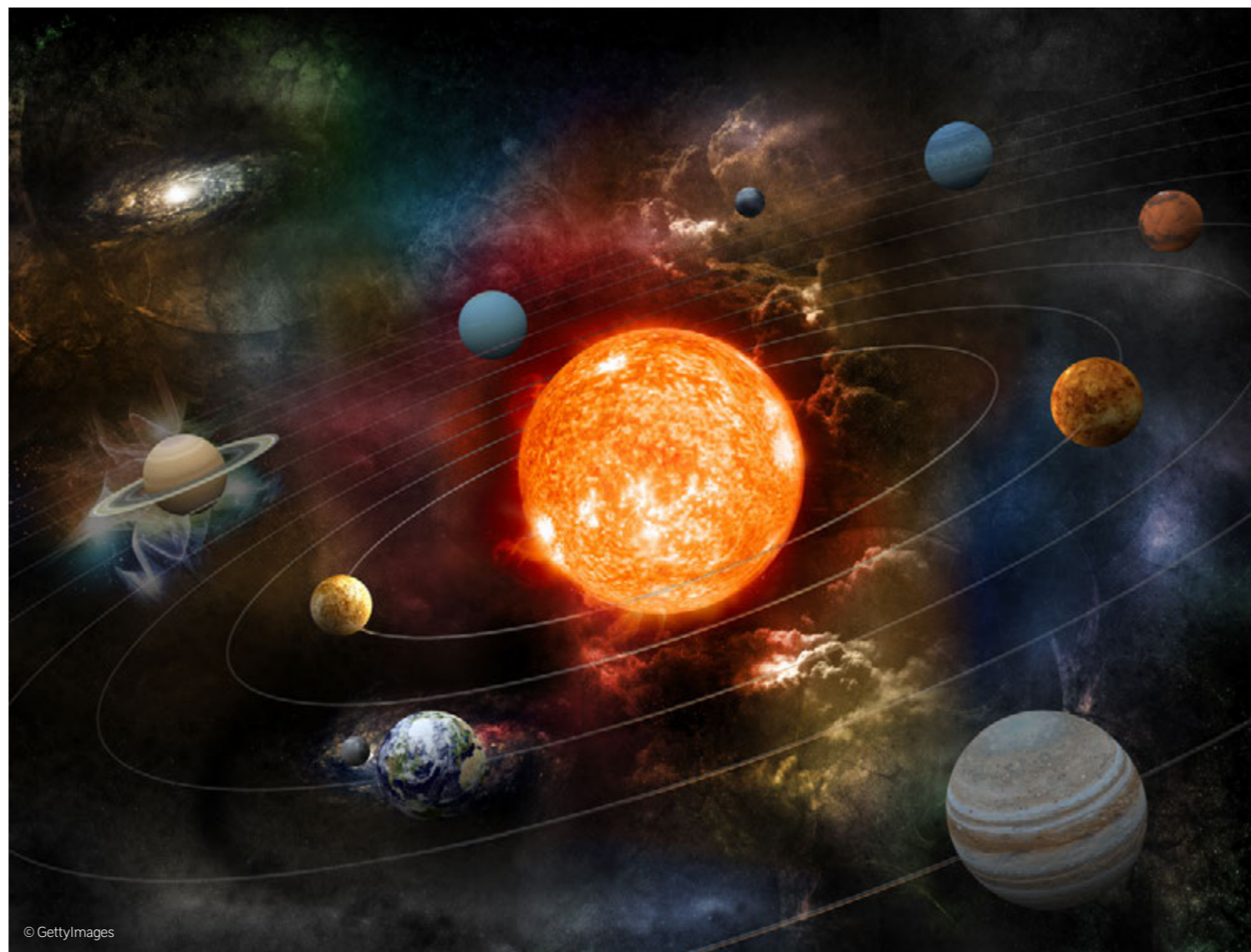

In the field of space exploration, for the first time in history, a planetary seismometer is operating on the surface of the planet Mars. SEIS (Seismic Experiment for Interior Structure), for which France has technical and scientific responsibility, was deployed on Martian soil by the lander of the InSight mission in December 2018. InSight is the first mission devoted to studying the internal structure of Mars. CNES is the prime contractor for SEIS and the IPGP Earth physics institute in Paris is principal investigator. Researchers and engineers from IPGP, Paris Diderot University, ISAE-SUPAERO Toulouse and CNRS (LPGN planetology and geodynamics laboratory in Nantes and LMD dynamic meteorology research laboratory in Palaiseau) complete the French team analysing SEIS data. Mars also took centre stage in 2020, with many missions departing Earth for the red planet and CNES together with French laboratories on board several of them. The SuperCam instrument on the Mars 2020 Perseverance rover consists of a camera, laser, three spectrometers and a microphone. This cutting-edge instrument is an international effort led by CNES, illustrating France's world-renowned prowess in space exploration. The Sun has not been left out of exploration plans, as the ESA Solar Orbiter probe was launched in 2020, approaching to within 40 million kilometres of our star to deliver new insights into the solar wind and its direct impacts on Earth. CNES supplied the Radio and Plasma Waves instrument (RPW), developed by a European consortium with a key role played by the LESIA space and astrophysics instrumentation research laboratory, the LPP plasma physics laboratory and the LPC2E environmental and space physics and chemistry laboratory in Orléans. This instrument provides in-situ and remote-sensing measurements of both electrostatic and electromagnetic fields and waves in a broad frequency range. Finally, we can

note that at the end of 2020 the first catalogue from the European Gaia satellite was published, revealing consolidated data—like distance, mass, velocity and temperature—on 1.8 billion stars in the Milky Way.

In 2021, in the field of scientific cooperation ESA astronaut Thomas Pesquet accomplished his Alpha mission on the International Space Station (ISS), during which he conducted over 200 experiments, 40 of them European and 12 new ones led by CNES. At the end of 2021, the NASA-ESA-CSA James Webb Space Telescope (JWST) was settling into orbit around the L2 Lagrange point. JWST is the most powerful telescope ever launched into space. With its significantly improved infrared resolution and sensitivity, JWST is capable of viewing objects too distant, old and faint for the Hubble Space Telescope. JWST's four instruments include MIRI (Mid-InfraRed Instrument), developed under the lead of ESA and national space agencies by a consortium of European laboratories. MIRI consists of two main parts: spectrometers developed by the Netherlands and the United Kingdom and the MIRIM imager developed in France under CNES's responsibility by the French atomic energy and alternative energies commission CEA, LESIA in Meudon, the LAM astrophysics laboratory in Marseille and the IAS space astrophysics institute in Orsay. This is another great example of national cooperation between research laboratories and CNES, as well as at the international scale.

2022 is also shaping up to be a busy one for CNES and France, with numerous events and rendezvous throughout the year. Already in February, Toulouse hosted three key meetings for European space: the Copernicus Symposium and the European Informal Meeting of Space Ministers, bringing together

policymakers from the EU, ESA and its member states. CNES is also engaging several initiatives to support and develop the French and European space industry under challenging New Space opportunities. The Connect by CNES programme encourages exchanges between the space sector and other sectors, continuing to support the downstream sector and the environment, mobility and health domains. This year, CNES takes over the presidency of the Committee on Earth Observation Satellites (CEOS), managing its mission to ensure international coordination of civil Earth-observation programmes and promote data sharing. In September, the 73rd International Astronautical Congress (IAC) will be taking place in Paris at the Porte de Versailles, while space ministers from the 22 ESA member states will be convening, also in Paris, on 22 and 23 November for the agency's Ministerial Council. Therefore, a very eventful year awaits us in space.

Finally, we feel it is appropriate once again to emphasize the crucial role that science plays and will continue to play in the growth and visibility of space activities in France, through its ability to chart the course over long periods of time, and therefore CNES's programmatic strategy. Science is indeed a fundamental driver for the agency, as expressed in the renewed CNES-Government (COP), Objectives and Performance Contract (OPC) in 2022. This will also direct France's positions at the European Space Agency in science in its broadest sense (Earth, universe, matter, life and exploration).



Manda Mioara
Head "Science Coordination"
Department, Strategy Directorate



Pascale Ultré-Guerard
Deputy Director for "Programmes",
Strategy Directorate



**SPACE STUDIES OF
THE EARTH'S SURFACE,
METEOROLOGY AND
CLIMATE**

© GettyImages

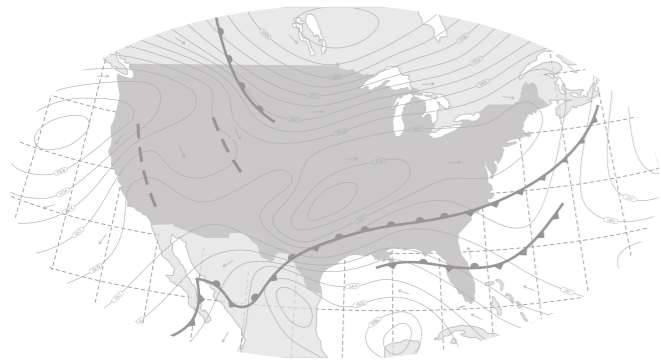

[Author: S.CHERCHALI]
Head of Earth Observation Department

[Author: P. MAISONGRANDE]
Land and Hydrology Programme Manager

1 SPACE STUDIES OF THE EARTH'S SURFACE, METEOROLOGY AND CLIMATE

Understanding the Earth system is an absolute necessity to address and adapt to climate change and its related impacts.

Strong scientific interest should be targeted at thematic Earth system components (the atmosphere, global ocean, solid Earth and continental land surfaces), but there is also an urgent need to support and promote studies on cross-cutting challenges such as climate science, coastal zones, the cryosphere, the water and carbon cycles, health-related issues, risks, the urban environment and so on.

CNES's Earth-observation programme is dedicated to addressing these urgent needs through a consistent set of actions: increased collaborations and partnerships at all scales, an improved combination of satellite, in-situ and model data from upstream (R&T) to downstream (applications) processes, and the provision of guidance on strategy and funding support to scientific committees (CPS / TOSCA).

/ VEN μ S



Artist's impression of the VEN μ S satellite.
© IDE/Robin Sarian, 2015

VEN μ S (Vegetation and Environment Monitoring on a micro Satellite) is a micro-satellite mission from the French and Israeli space agencies (CNES,ISA) launched on 1 August 2017. It is carrying two payloads:

- the Israeli payload is an experimental ion thruster which has been used to drastically change the altitude of the satellite several times, and to maintain an orbit at a very low altitude (410 km) during three months
- the French payload, built by an Israeli contractor, is a high-resolution (5 m) imager, with 12 spectral bands in the visible and near infrared.



Left, the different phases of the VEN μ S mission, and right, the selected sites during VM1.

The orbits of the imaging VM1 and VM5 imaging phases were chosen to allow very frequent observations of more than 100 sites. For the VM1 phase, which lasted from January 2018 to October 2020, each selected site was observed every other day, while in the VM5 phase, which started early in 2022, the chosen sites are observed every day, always with a constant viewing angle per site. The call for sites for the VM5 phase received 90 proposals, counting more than 200 sites in total.

The data are used to show the interest of very frequent, high-quality imagery. The mission has enabled topflight scientific work on the use of multi-temporal revisits to better detect clouds and

correct atmospheric effects [1], to monitor vegetation phenology [2], to drive vegetation growth models [3], or to estimate bathymetry using the motion of waves [4]. It is also being used to help in the preparation of future missions such as the next generation of Sentinel-2 satellites, or a complementary mission that would provide systematic VHR missions with less frequent revisits (CNES Sentinel-HR phase 0).

The data from the VM1 phase, and soon from VM5, are available from the Theia catalogue: <https://theia.cnes.fr/atdistrib/rocket/#/search?page=1&collection=VENUS>

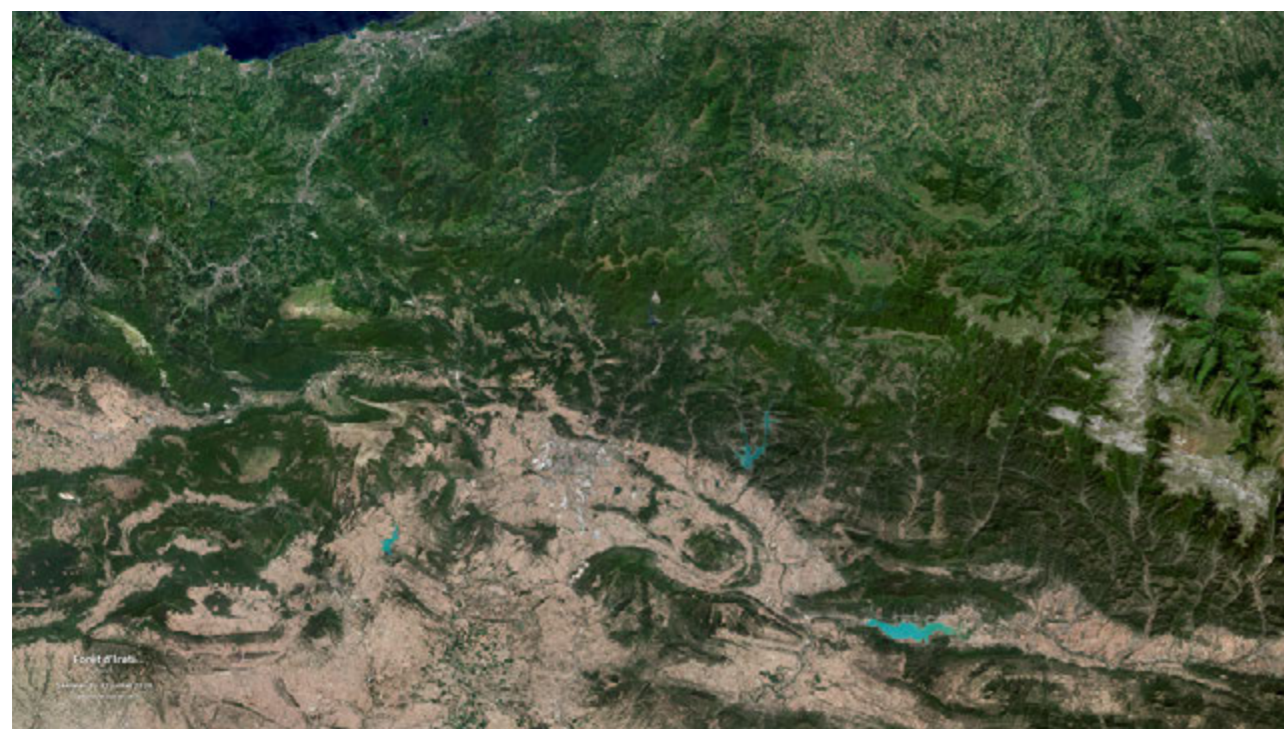

Irati Forest, straddling France and Spain, seen by the Sentinel-2 satellite. © Copernicus Sentinel Data, 2020

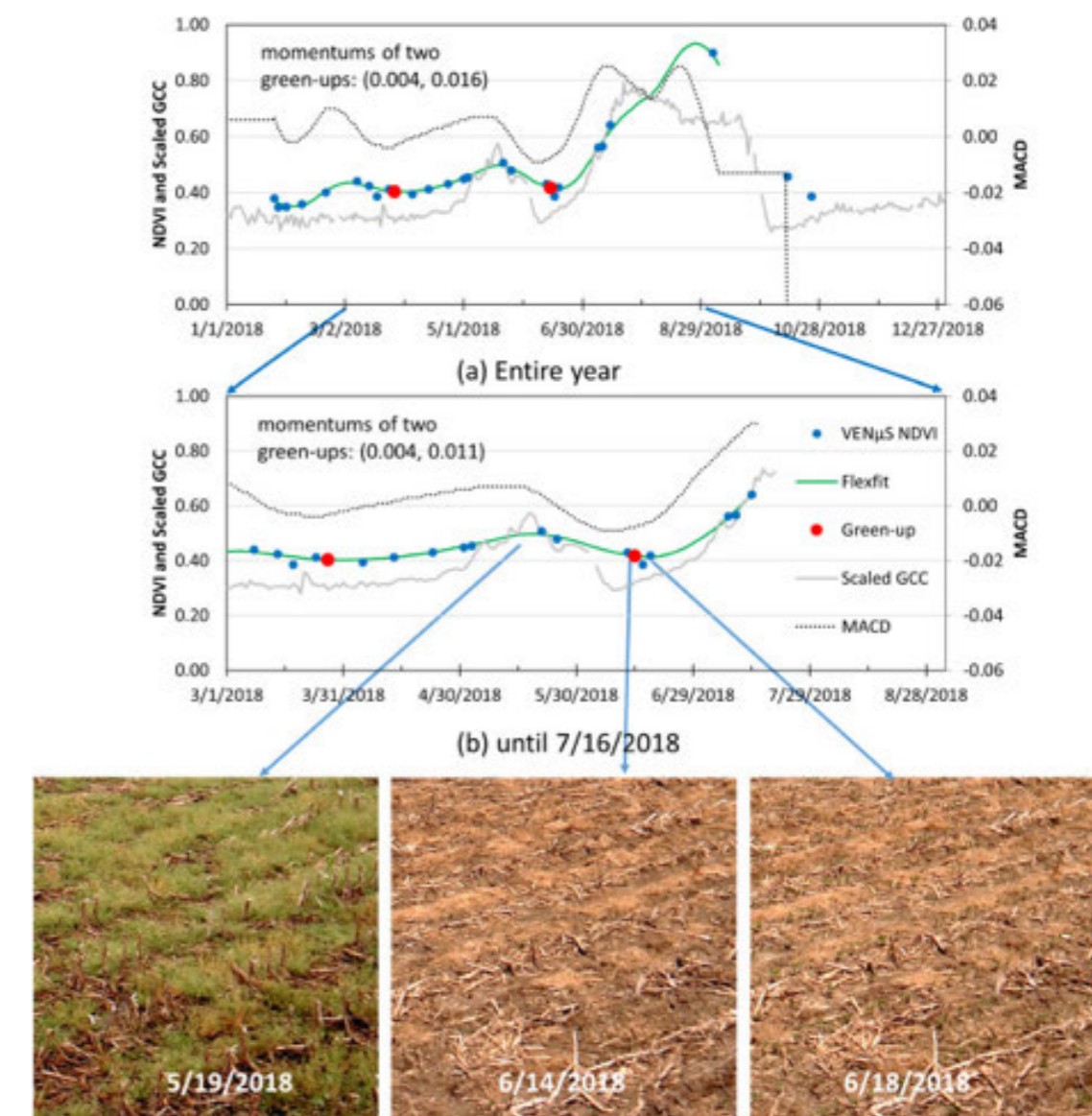

Accurate detection of vegetation green-up events using VEN μ S dense time series. From [2].

REFERENCES

[1] Hagolle, O., Huc, M., Villa Pascual, D., Dedieu, G., 2015. A multi-temporal and multi-spectral method to estimate aerosol optical thickness over land, for the atmospheric correction of FormoSat-2, LandSat, VEN μ S and Sentinel-2 images. Remote Sensing 7, 2668–2691.

[2] Gao, F., Anderson, M., Daughtry, C., Karnieli, A., Hively, D., Kustas, W., 2020a. A within-season approach for detecting early growth stages in corn and soybean using high temporal and spatial resolution imagery. Remote Sensing of Environment 242, 111752.

[3] Upreti, D., Pignatti, S., Pascucci, S., Tolomio, M., Huang, W., Casa, R., 2020. Bayesian Calibration of the Aquacrop-OS Model for Durum Wheat by Assimilation of Canopy Cover Retrieved from VEN μ S Satellite Data. Remote Sensing 12, 2666.

[4] Bergsma, E.W., Almar, R., Rolland, A., Binet, R., Brodie, K.L., Bak, A.S., 2021. Coastal morphology from space: A showcase of monitoring the topography-bathymetry continuum. Remote Sensing of Environment 261, 112469.

[Author: P. MAISONGRANDE]

Land and Hydrology Programme Manager

// TRISHNA

TRISHNA [1] (*Thermal infraRed Imaging Satellite for High-resolution Natural resource Assessment*) is a satellite mission from the French and Indian space agencies (CNES, ISRO), to be launched in 2025. It will carry two payloads:

- The Indian payload is a multispectral imager with a wide field of view (+/- 33 degrees), a moderately high resolution of 60 m and (spectral bands in the visible, near infrared and short-wave infrared. It is built around six small push-broom cameras, as the SWIR and VNIR bands are separate instruments, and for both of them, three cameras are needed to cover the whole field of view.
- The French payload [3], built by Airbus Defence and Space, has the same field of view and resolution, but provides four bands in the thermal infrared [2]. It is a scanner, which also observes a blackbody and deep space at each rotation of its mirror.

The TRISHNA mission will focus on the estimation of evapotranspiration, and will contribute to detection of water stress, monitoring of irrigation and its management. It will provide direct information on the use of water and in particular its consumption by agriculture. These data will also indirectly contribute to water availability assessments and studies on the natural or anthropogenic causes of variations in groundwater level.

Without TRISHNA, the community lacks information at the plot level and with sufficient revisit frequency, to assess water consumption, which varies greatly depending on the type of crop and agricultural practices. With TRISHNA, it is possible to estimate this consumption, and even to optimize it, by providing the farmer with data to aid irrigation

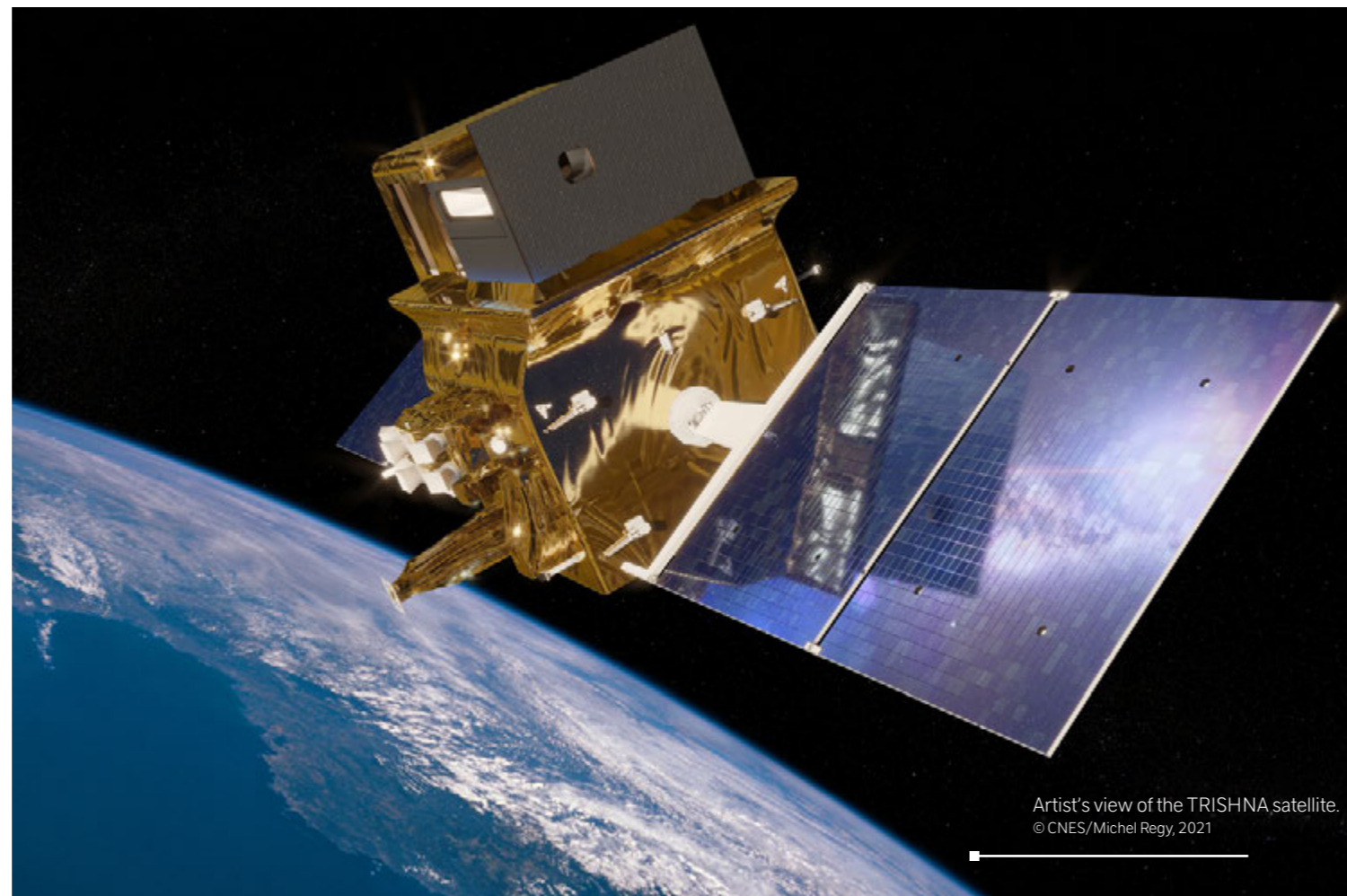

Artist's view of the TRISHNA satellite.
© CNES/Michel Regy, 2021

decision-making. It will also be possible to detect any crop water stress and deduce yield losses by modelling, with better precision than with optical data of the Sentinel-2 type, which cannot detect water stress before the canopy begins to turn yellow.

Thanks to TRISHNA, data collected on the dynamics of evapotranspiration will become more precise to allow better management of water resources and

to define new agricultural practices in response to climate change with a view to enabling sustainable and smarter agriculture.

In addition, TRISHNA will provide the necessary information to develop early-warning tools to prevent the effects of droughts on croplands or for issues related to the health of forest ecosystems. It will enable monitoring of wetland and coral reef

health, water surface temperature in coastal or inland water bodies, or the cryosphere and of urban heat islands [4].

The joint project team is led by ISRO and CNES. The science team comprises members of the French and Indian scientific communities, with representatives of other thermal infrared missions (ECOSTRESS, LSTM, SBG), in order to stimulate scientific cooperation, for the benefit of all. More than 200 researchers interested in all the coming high-resolution TIR missions gathered for a *first symposium* in Toulouse in March 2022.

REFERENCES

- [1] Lagouarde, J. P., Bhattacharya, B. K., Crebassol, P., Gamet, P., Babu, S. S., Boulet, G., ... & Ramakrishnan, R. (2018, July). The Indian-French Trishna mission: Earth observation in the thermal infrared with high spatio-temporal resolution. In IGARSS 2018-2018 IEEE International Geoscience and Remote Sensing Symposium (pp. 4078-4081). IEEE.
- [2] Vidal, T. H., Gamet, P., Oliosio, A., & Jacob, F. (2022). Optimizing TRISHNA TIR channels configuration for improved land surface temperature and emissivity measurements. *Remote Sensing of Environment*, 272, 112939.
- [3] Buffet, L., Gamet, P., Maisongrande, P., Salcedo, C., & Crebassol, P. (2021, June). The TIR instrument on TRISHNA satellite: a precursor of high resolution observation missions in the thermal infrared domain. In International Conference on Space Optics—ICSO 2020 (Vol. 11852, p. 118520Q). International Society for Optics and Photonics.
- [4] Granero-Belinchon, C., Michel, A., Lagouarde, J. P., Sobrino, J. A., & Briottet, X. (2019). Multi-resolution study of thermal unmixing techniques over Madrid urban area: Case study of TRISHNA mission. *Remote Sensing*, 11(10), 1251.

[Author: C.DENIEL]
 Atmospheric Composition Programme Manager

/// IASI

IASI (CNES-EUMETSAT instruments): a climate sentinel from space

Between 2006 and 2021, three IASI instruments developed by CNES for Eumetsat's Metop low-Earth-orbit meteorological programme have delivered excellent quality data, and since 2015 CNES is developing the new generation of the IASI NG instrument to pursue acquisition of data in the coming decades. With the constant stream of data from this atmospheric thermal infrared hyperspectral sounder over more than 30 years, long-term evolution of essential climate variables (ECVs) can be monitored to understand processes and predict climate change in the future. Of the 16 atmospheric ECVs defined by GCOS, 13 are observed by IASI.

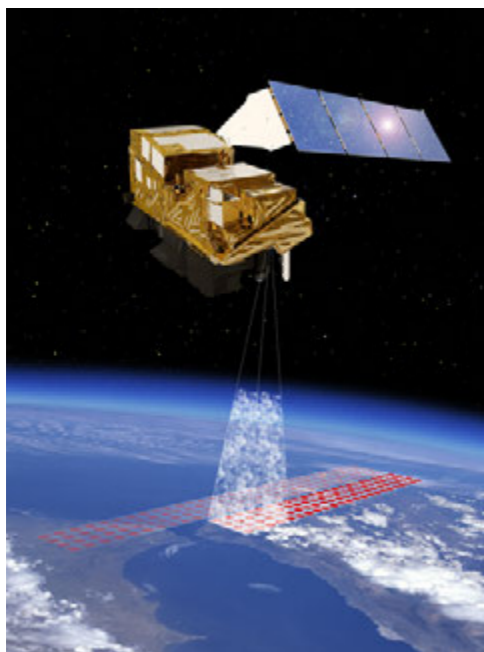

Artist's view of the MetOp-SG satellite.
 © CNES/Michel Regy, 2021

Ever more greenhouse gases in the atmosphere

For the two major anthropogenic greenhouse gases, carbon dioxide (CO₂) and methane (CH₄), IASI offers a unique platform from space since 2006 to observe the evolution of their atmospheric concentrations, which grew from 380 to 415 ppm in 15 years for CO₂ and from 1,820 to almost 1,900 ppb for CH₄ in the last nine years with an unprecedented acceleration in the last two years (2020/21) (see figures courtesy C. Crevoisier LMD/IPSL).

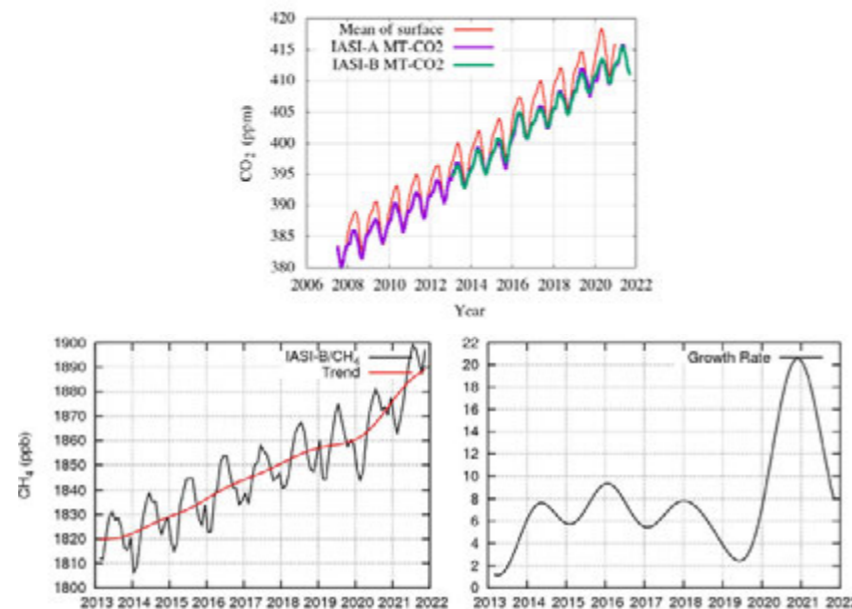

Despite a reduction in global emissions of CO₂ of about 7% in 2020 due to lockdowns, IASI confirms that both gases still exhibit a steady growth rate in the mid-troposphere.

Underestimation of pollution by ammonia

During the COVID-19 pandemic, lockdowns reduced anthropogenic emissions of NO₂ in Paris. The concentrations of this polluting species recorded in 2020 were the lowest they have been in the past five years. Despite these low-NO₂ levels, Paris experienced PM_{2.5} pollution episodes, which were investigated based on multi-species and multi-platform measurements from the ground and space. In

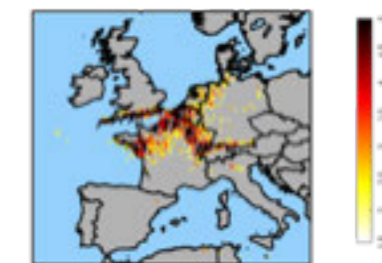
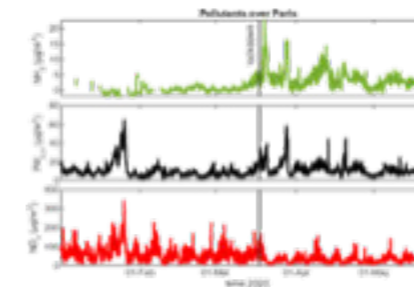

Europe, nationwide lockdowns restricted traffic and slowed down industrial production. Particles (PM), directly related to those activities, were expected to be reduced. However, agricultural activities, were thus responsible for NH₃ emissions and precursors of PM, continued. In early spring, farmers usually apply fertilizers, which results in a yearly peak of atmospheric NH₃ in this time period. This seems to be the case during the warm and dry 2020 spring.

Ammonia and PM_{2.5} concentration measured from the ground-based in-situ instruments over Paris during the 2020 COVID lockdown (right) and ammonia column measured by IASI on 27 and 28 March 2020.

Hyperspectral infrared satellite sounders provide daily NH₃ observations at global scale for over a decade to derive global, regional and national trends from 2008 to 2018. Excess atmospheric ammonia (NH₃) leads to deleterious effects on biodiversity, ecosystems, air quality and health, and it is therefore essential to monitor its budget and temporal evolution. The worldwide increase detected by IASI is about 12.8 ± 1.3% over this 11-year period, driven by large increases in East Asia, Western and Central Africa, North America and Western and Southern Europe. These are also seen in the Indo-Gangetic Plain, while southwestern India exhibits decreasing trends. Reported national trends are analyzed in

the light of changing anthropogenic and pyrogenic NH₃ emissions, meteorological conditions and the impact of sulphur and nitrogen oxides emissions, which alter the atmospheric lifetime of NH₃. We end with a short case study dedicated to the Netherlands and the 'Dutch Nitrogen crisis' of 2019.

REFERENCES

Martin Van Damme^{1,3*}, Lieven Clarisse^{1,3*}, Simon Whitburn¹, Juliette Hadji-Lazaro², Daniel Hurtmans¹, Cathy Clerbaux^{1,2} & Pierre-François Coheur¹, Industrial and agricultural ammonia point sources exposed, Nature REsaerch letter, 2018, <https://doi.org/10.1038/s41586-018-0747-1>

Viatte, C., Wang, T., Van Damme, M., Dammers, E., Meleux, F., Clarisse, L., Shephard, M. W., Whitburn, S., Coheur, P. F., Cady-Pereira, K. E., and Clerbaux, C.: Atmospheric ammonia variability and link with particulate matter formation: a case study over the Paris area, Atmos. Chem. Phys., 20, 577–596, <https://doi.org/10.5194/acp-20-577-2020>, 2020

[Author: A.SYLVESTRE-BARON]
 Ocean Programme Manager

//// CALIPSO

Overview and Objectives

Launched on 28 April 2006, the CALIPSO mission fills a now well-recognized crucial need for high-resolution atmospheric profiling, and provides essential observations for reducing the uncertainties that limit our understanding of the role of aerosols and clouds in the global climate system.

CALIPSO data products are routinely produced, archived, and distributed to scientific researchers worldwide by data centres in the United States and France. Expedited products are designed to meet the near-real-time data delivery requirements of field campaigns and operational forecast centres and are generated immediately upon receipt of the downlinked data using climatological data. Standard products are produced later, using temporally matched meteorological reanalysis data and more sophisticated processing. Four releases of the standard data products have offered improvements in retrieval accuracies and uncertainty characterization.

CALIPSO's three-year nominal mission was completed in spring 2009, and the project was granted six mission extensions following the NASA Earth Science Mission Directorate Senior Reviews and CNES Revue D'Extension Mission (REDEM) in 2009, 2011, 2013, 2015, 2017 and 2020. 15 years of data are now available.

CALIPSO is expected to remain operational until 2023. The next CALIPSO mission review will take place in 2021. Next operation years will help to complement the unique set of synergistic measurements



Artist's view of the CALIPSO satellite.
 © P. Carril, July 2004

being acquired and will significantly enhance our ability to characterize the processes that control the seasonal and inter-annual variability of clouds and aerosols on regional and global scales. Continuing the mission will also establish important links with recent and future spaceborne lidar missions (e.g., Aeolus and EarthCare), foster synergies with the new SAGE III and geostationary instruments, and continue to offer opportunities to monitor the rapidly on-going effects of a changing climate (aerosol emissions by forest fires, role of clouds in the Arctic climate, impact of the drastic change in emissions during the COVID-19 lockdown, etc.).

Achievements

CALIPSO's co-aligned lidar and IIR measurements and robust retrieval techniques have led to significant advances in cloud and aerosol retrievals, both by themselves and in synergy with other A-Train instruments.

Observationally-based estimates of all-sky aerosol direct radiative effect (DRE) are now made possible by CALIPSO's unique ability to measure aerosols in cloudy skies. CALIPSO's ability to directly observe cloud altitude and thermodynamic phases provides key insights into the feedbacks between Arctic cloud cover, sea ice extent, sea ice life cycle, and the thinning of Greenland's ice sheets. CALIPSO's vertical profile measurements of clouds and aerosols are a unique resource to evaluate weather forecast and climate models, air quality models, and models used to forecast volcanic plume dispersion.

CALIPSO data have been embraced by the science community, as shown by over 3,100 articles in peer-reviewed journals (the annual number peaked at 363 in 2019 and is 331 in 2020).

CALIPSO observations and data products thus continue to be widely used throughout the international scientific community.

Publications include more than 200 Ph.D. dissertations, and about 10% in France. With each year, CALIPSO data are used in increasingly sophisticated ways and there is increasing use of merged data products, including products that combine CALIPSO and CloudSat measurements with A-Train passive sensor data. CALIPSO observations have been widely adopted by the modelling community and particularly by the CFMIP cloud-climate feedback community: more than two dozen published papers have used CALIOP cloud observations to evaluate the representation of clouds in climate models, taking advantage of the French-led GOCCP dataset. A complete bibliography of peer-reviewed CALIPSO publications can be found online here:

<http://www-calipso.larc.nasa.gov/resources/bibliographies.php>

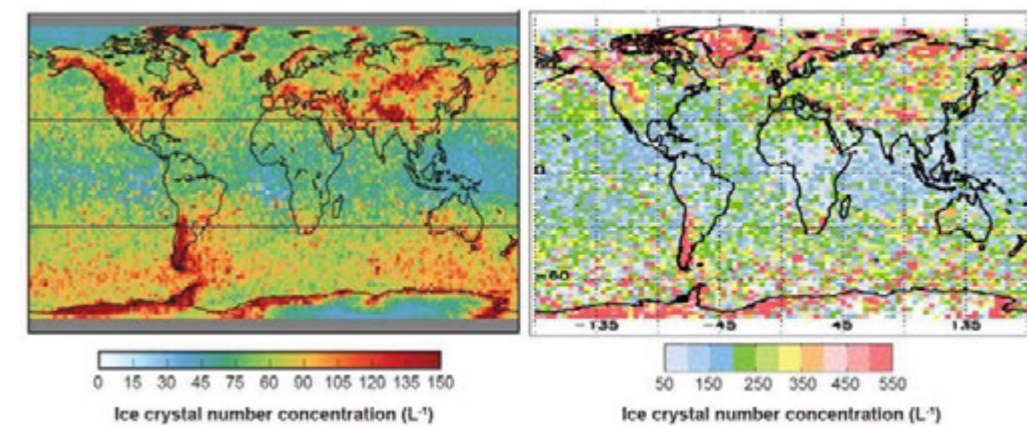

Comparison of the global distribution of relative ice particle concentration. (Left) cloud top ice concentration for clouds with top temperature equal to 223 K (Right) ice concentration in clouds of radiative temperature between 218 and 228 K.

[Author: A.SYLVESTRE-BARON]
Ocean Programme Manager

//// CFOSAT

CFOSAT (China France Oceanography Satellite) is an innovative mission from the Chinese and French space agencies (CNSA, CNES), launched on 29 October 2018, carrying two Ku-Band active instruments, SWIM measuring ocean surface wave direction, and SCAT measuring wind vectors.

With respect to existing satellite missions, the original feature of CFOSAT is that it provides continuous, co-located wind vector fields and directional spectra of ocean waves for wavelengths in the range of about [30-500] metres. It also provides the normalized radar cross-section in a multi-incidence and multi-azimuth geometry, which can be used to improve the inversion algorithms for estimating wind speed and significant wave height and to characterize the small-scale roughness of all types of surfaces.

CFOSAT is contributing to global wind field observations alongside existing scatterometer missions (e.g. ASCAT on METOP, SCAT on HY-2A and HY-2B), and to speed and significant wave height measurement alongside other altimeter missions (like the Jason or HY-2 series, Sentinel-3). Furthermore, it provides complementary information on wave properties with respect to SAR missions (like Sentinel-1), by giving access to directional spectra of ocean waves not only for long swells but also for wind waves and mixed sea conditions, whatever the direction of these waves.

CFOSAT products produced either in near-real time (NRT) or non-time-critical (NTC) products are currently open to all users, including operational services:

<https://www.aviso.altimetry.fr/>
<https://www.odatis-ocean.fr/en/>
<https://resources.marine.copernicus.eu/>

CFOSAT has already demonstrated its potential for contributing to important fields of research, especially atmosphere/ocean exchanges, ocean wave physics, sea-ice monitoring, atmospheric, wave and oceanic modelling or forecasting, and monitoring of wind and wave fields. Thanks to the new types of observations (directional wave spectra), it is also a key element paving the way for future oceanographic satellite missions such as those devoted to surface current measurements and new-generation altimetry concepts.

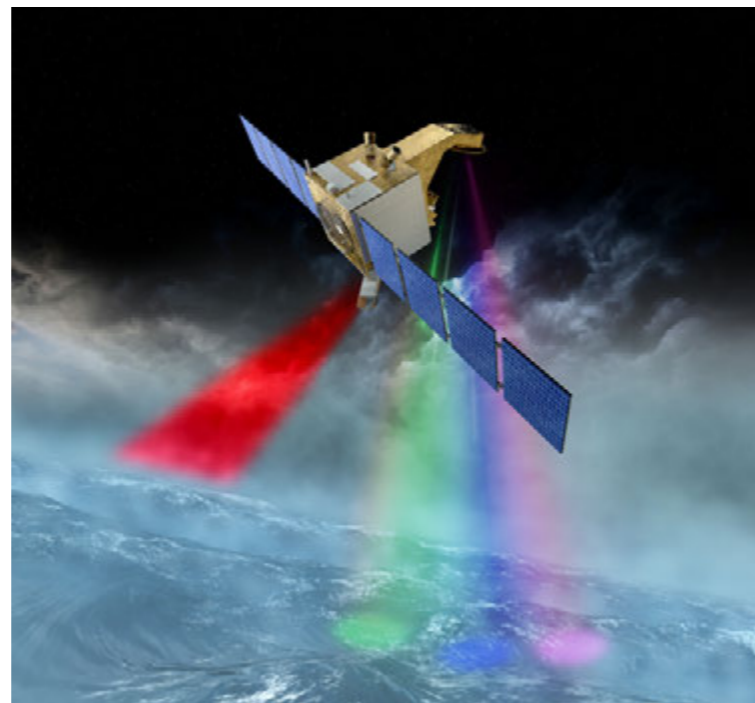

Artist's view of the CFOSAT satellite. The illuminating beams of the SCAT instrument (red) and SWIM instrument (multi-colour) instruments are illustrated.
© CNES/Olivier Sattler, 2017

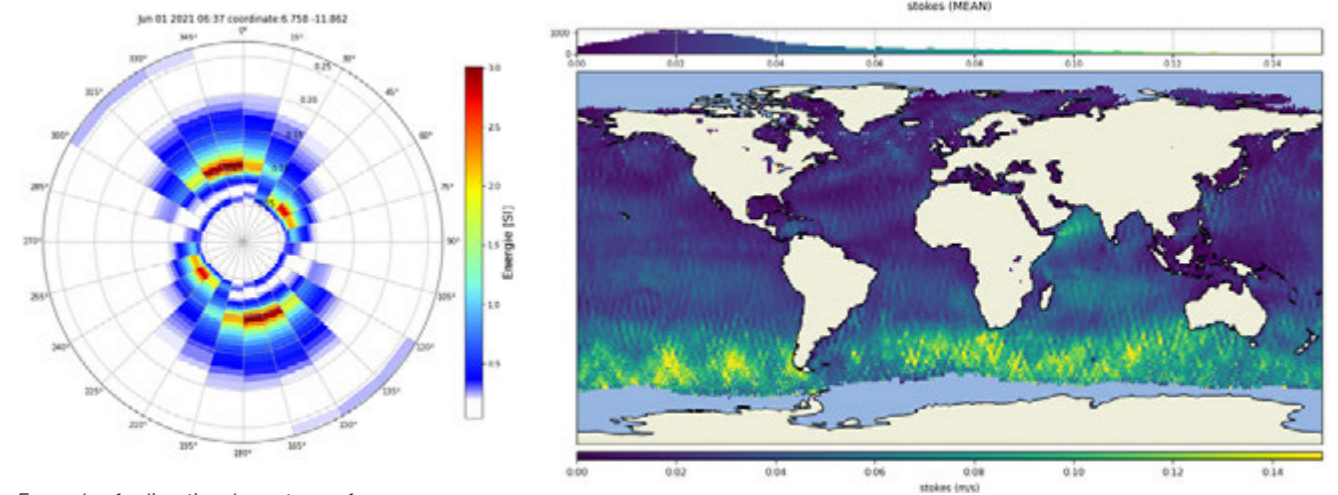

Example of a directional spectrum of ocean waves as estimated from the SWIM instrument on 1 June 2021 (at 6.76N, -11.86 W). This example illustrates the capability of SWIM to detect both the swell (wave energy in colour around the 60°-240° direction) and the wind sea (wave energy in colour around the 165°-345° direction).

Mean of Stokes drift intensity in July 2021 computed from SWIM wave spectra. The Stokes drift is a current at the ocean surface due to the presence of waves. It depends on the spectral distribution of wave energy. Combined with the Ekman drift due to the wind, it is an important parameter which characterizes the air/sea interface.

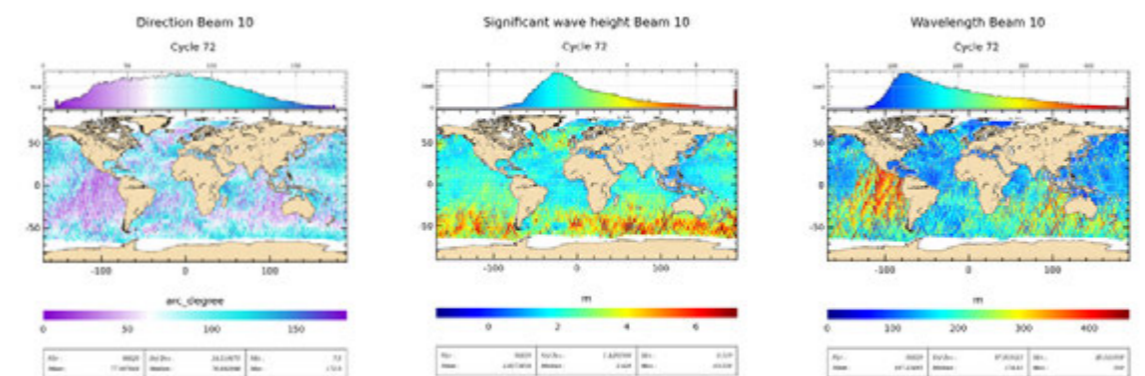

Composite maps of wave parameters (significant wave height, dominant wavelength, and dominant directions, with an ambiguity of 180°) estimated from the SWIM data. These maps were obtained over a period of 13 days.

REFERENCES

- [1] D. Hauser, C. Tourain, L. Hermozo, D. Alraddawi, L. Aouf, et al. (2021). New observations from the SWIM radar on board CFOSAT: instrument validation and ocean wave measurement assessment, IEEE Transactions on Geoscience and Remote Sensing, vol. 59, no. 1, pp. 5-26, <https://doi.org/10.1109/TGRS.2020.2994372>
- [2] C. Tourain, F. Piras, A. Ollivier, D. Hauser, F. Poisson, F. Boy, P. Thibault, L. Hermozo, C. Tison. (2021). Benefits of the adaptive algorithm for retracking altimeter nadir echoes: results from simulations and CFOSAT/SWIM observations, IEEE Transactions on Geoscience and Remote Sensing, vol. 59, no. 12, pp. 9927-9940, <https://doi.org/10.1109/TGRS.2021.3064236>
- [3] L. Aouf, D. Hauser, B. Chapron, A. Toffoli, C. Tourain, and C. Peureux. (2020). New Directional Wave Satellite Observations: Towards Improved Wave Forecasts and Climate Description in Southern Ocean, Geophysical Research Letters, 48, e2020GL091187, <https://doi.org/10.1029/2020GL091187>
- [4] C. Peureux, N. Longépé, A. Mouche, C. Tison, C. Tourain, J-M. Lachiver, D. Hauser. (2022). Sea-ice detection from near-nadir Ku-band echoes of CFOSAT/SWIM scatterometer, Earth and Space Science, 9, e2021EA002046, <https://doi.org/10.1029/2021EA002046>.

[Author: A.SYLVESTRE-BARON]
 Ocean Programme Manager

// // // // SWOT

Artist's view of the SWOT satellite.
 © CNES/ill.D. Ducros

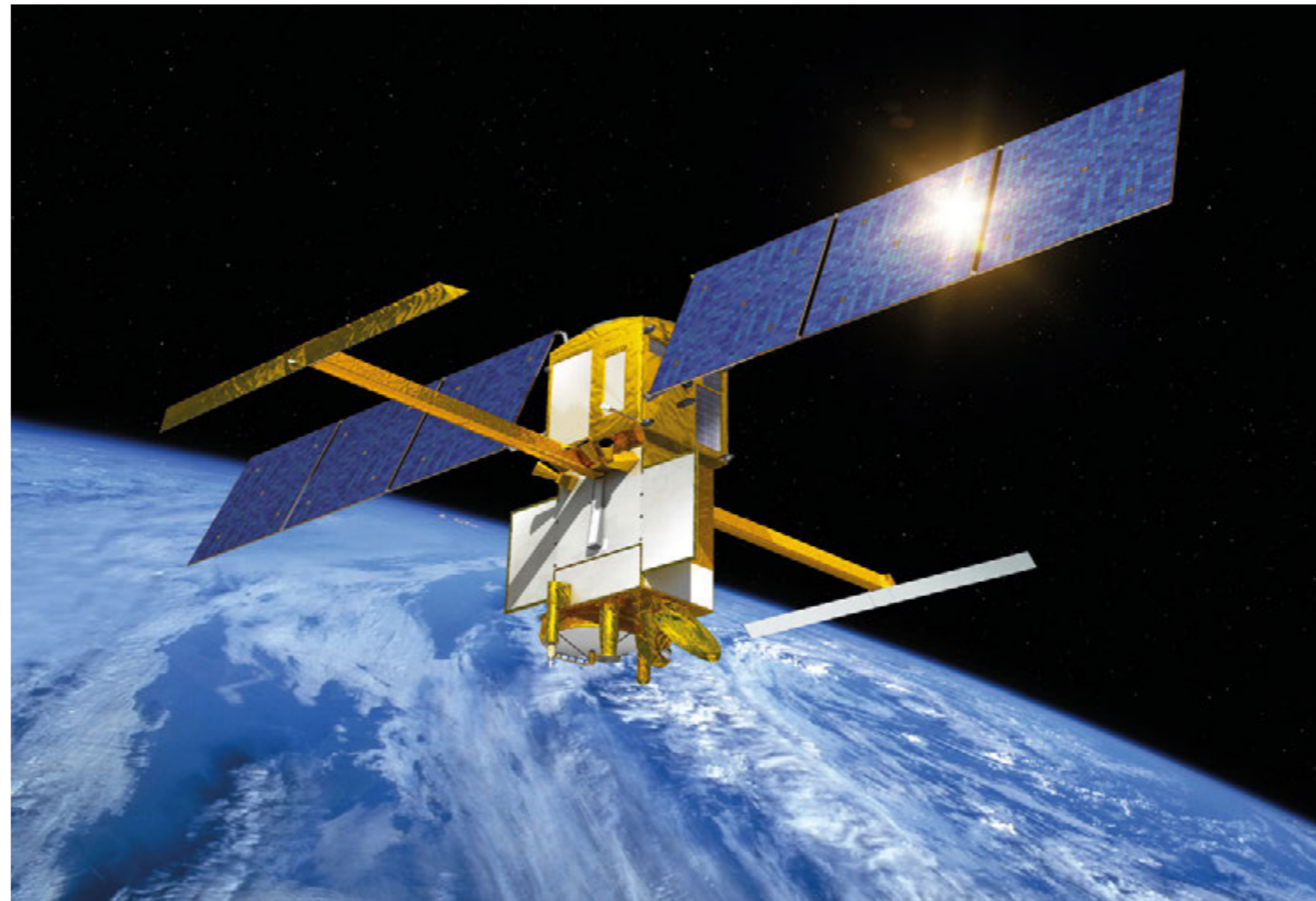

Surface Water and Ocean Topography (SWOT) is the promising and innovative altimetry satellite mission jointly developed by NASA and CNES, the French space agency, in partnership with the Canadian Space Agency (CSA) and UK Space Agency (UKSA), to be launched no earlier than 18 November 2022. The objectives of the mission are to complete the first global survey of Earth's surface water, to observe the fine details of the ocean surface topography, and to measure how terrestrial surface water bodies change over time. While past satellite missions like the Jason series altimeters (TOPEX/Poseidon, Jason-1, Jason-2, Jason-3, Jason CS (Sentinel-6 Michael Frielich)) have provided variation in river and lake water surface elevations at select locations, SWOT will provide the first truly global observations of changing water levels, slopes and flood extents in rivers, lakes and floodplains. It will no longer only measure along the ground tracks of its orbit, but provide near-total coverage of the globe (with the notable exception of the poles) thanks to its wide-swath radar interferometer. The orbit has been chosen so that swaths are contiguous when crossing the equator. This mission will acquire at least two measurements per 21-day cycle. SWOT will observe ocean circulation at unprecedented scales, approximately an order of magnitude finer than current satellites. Because it uses wide-swath altimetry technology (innovative KaRin altimeter), SWOT will observe almost all of the world's oceans

and freshwater bodies with repeated high-resolution elevation measurements, thus allowing observations of variations.

The main objectives of SWOT for hydrology are the study of hydrological processes and the understanding of the role and impact of water storage change on the global water cycle, the sensitivity of

the surface water cycle to human activities (irrigation, transboundary water management), and extreme events (droughts and floods). The dynamic of floodplains and their role in the terrestrial carbon budget will be studied. A global inventory of the spatial distribution of surface waters and their spatio-temporal variability will be released to the scientific community. Moreover, the discharge of

ivers worldwide will be estimated and the connectivity between rivers, lakes, and floodplains will be modelled. Thousands of rivers worldwide will be covered by SWOT in an unprecedented inventory. SWOT will fill gaps in knowledge about how lakes interact with climate processes. Another goal is to assimilate SWOT data into GCM models, where generally lakes and rivers are poorly represented [2]. SWOT will provide an independent, reliable and accurate measurement system of diverse variables controlling flow and water storage changes at basin scale [3].

The ocean is the planet's largest reservoir of heat and carbon dioxide, which are distributed by currents. Global ocean circulation balances Earth's climate and makes our planet habitable. Existing Earth-observing satellites have revealed much about the ties between climate and the ocean, including global warming and sea level rise. These sensors have also monitored currents associated with the large-scale hills and valleys (topography) at the sea surface, with scales > 100 km, features that change on seasonal and interannual timescales and due to intense climate fluctuations such as during El Niño and La Niña conditions. However, many ocean motions occur at scales too small to be detected globally with today's technology. These small-scale ocean currents contain most of the energy that drives the mixing and transport of water, and thus are important factors in assessing climate change. Moreover, ocean currents and eddies at these small scales are important in regional and coastal seas, and affect processes such as ship navigation, beach erosion and dispersal of pollutants.

An applications programme has been put in place from the inception of SWOT and is continuing through launch and operations. This programme promotes the use of unique SWOT data products to a community of end-users who are interested in using them in their applications, as well as to decision-makers.

Illustration of how SWOT's innovative wide-swath altimeter works over ocean and inland.

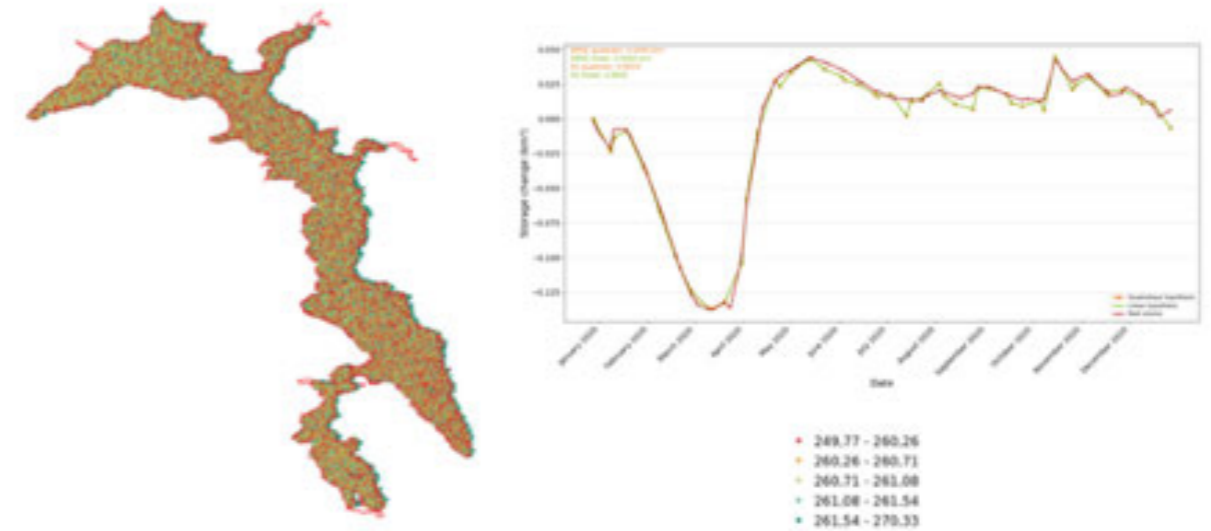
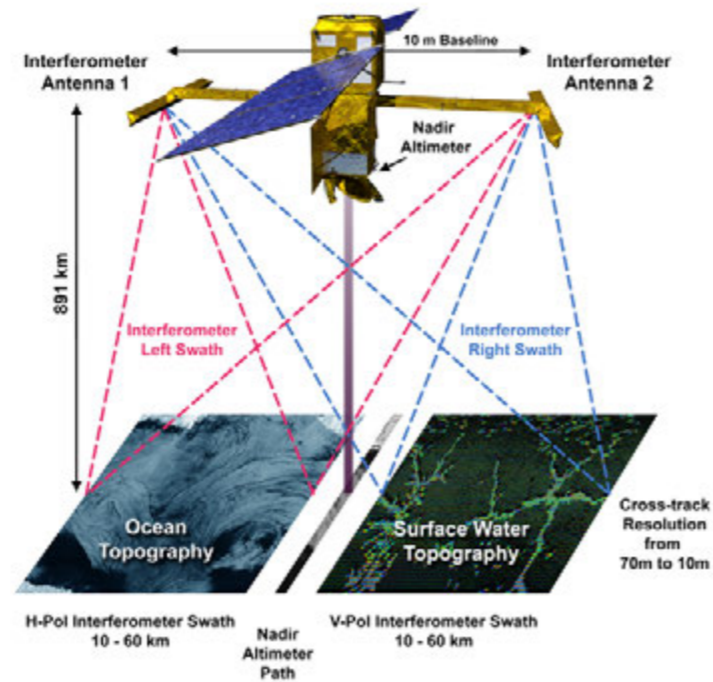

Simulation of volume change of lakes using SWOT data. The lake in this illustration is Lake François in Canada (Quebec region). The left of the figure shows the simulated pixel cloud data that will be released by SWOT's interferometer, and the right plots the volume changes from real and simulated data. It shows the quite high accuracy that we expect from SWOT for volume change determination. On a series of 30 lakes, the relative errors never exceeded 10% of the average volume of the lake.

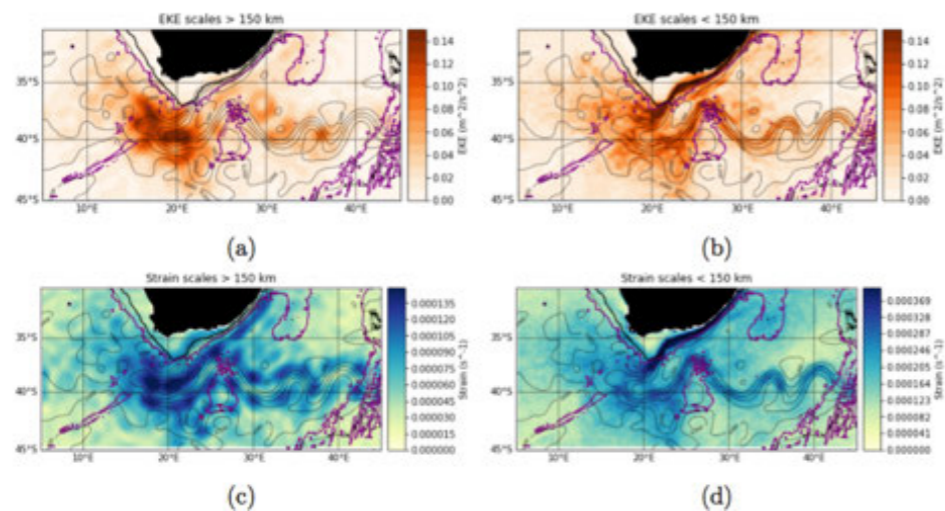

Model estimates of 2D ocean eddy diagnostics at scales > 150 km observed today with multi-mission gridded altimetry data (left panels), and at smaller scales from 15-150 km that should be observed by SWOT (right panels). Top panels show ocean surface geostrophic eddy kinetic energy (EKE). Bottom panels show ocean surface geostrophic strain, or eddy deformation, which is based on horizontal gradients of geostrophic currents and often associated with stronger vertical velocities. With the smaller scales observed by SWOT (right panels), we expect to have much finer EKE and strain resolution in the western boundary currents, and along the axes of major currents. Today's strain observations may be underestimated by a factor of three compared to SWOT observations.
© LEGOS

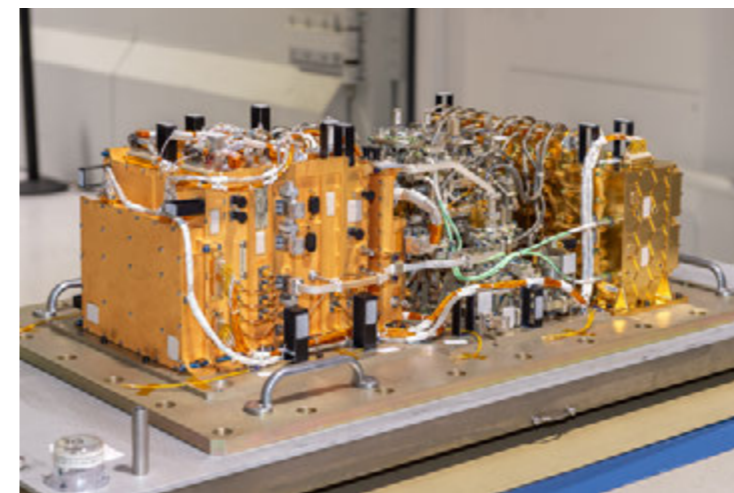

The Radio Frequency Unit, a CNES key hardware contribution to the innovative instrument KaRin instrument (Ka Radar Interferometer). CNES is also providing the satellite, the Satellite Control Centre and the Mission Centre (payload operations and science data processing). CNES and the French science community are key players in SWOT performance.
© CNES/Laurent Barranco, 2019

REFERENCES

- [1] Morrow, R., L-L Fu, F Arduini, M Benkiran, B Chapron, E Cosme, F D'Ovidio, J. T Farrar, S.T. Gille, G Lapeyre, P-Y Le Traon, A Pascual, APonte, B Qiu, N Rasclé, C Ubelmann, J Wang, E D. Zaron. (2019) Global observations of fine-scale ocean surface topography with the Surface Water and Ocean Topography (SWOT) Mission. *OceanObs2019, Frontiers in Marine Science*, DOI: 10.3389/fmars.2019.00232.
- [2] Biancamaria, S., K.M. Andreadis, M. Durand, et al. (2010) Preliminary characterization of SWOT hydrology error budget and global capabilities. *IEEE JSTARS Special Issue on Microwave Remote Sensing for Land Hydrology Research and Applications*, 3 (1), 6-19, DOI: 10.1109/JSTARS.2009.2034614.
- [3] Cretaux, J-F, S. Biancamaria, A. Arsen, M. Bergé-Nguyen, and M. Becker. (2015) Global surveys of reservoirs and lakes from satellites and regional application to the Syrdarya river basin, *Environmental Research Letter*, 10,1, AN: 015002, DOI: 10.1088/1748-9326/10/1/015002.

[Author: R.MORENO]
 Senior expert in EO & 'Data Terra' Research
 Infrastructure Technical Director

//////// DATA CLUSTERS

To be able to answer societies' questions about their environment, research needs to address the "Earth System" as a whole, from the Earth's core to the edge of the atmosphere, taking into account the interactions of its various components, and to explore all aspects ranging from the physical environment to the living environment.

Observation occurs at different stages of the scientific process: description, understanding, modelling and forecasting. Technical progress is providing us with increasingly diverse capabilities generating ever-richer datasets. However, using or accessing these datasets can be made difficult by the variety of data types, their volume, the complexity of their underlying processing, and their distribution and location. In order to make the most of this unprecedented supply of data for the benefit of knowledge and society, all data centre policies need to be aligned and appropriate approaches must be defined to process, archive and distribute the validated data and products derived from them.

Therefore, based on the final report of the working group initiated by CNES and CNRS-INSU, national research organizations agreed (at the end of 2013) to set up four national data clusters for coordinated management and centralized access to data. Each of these clusters covers a major compartment of the Earth system (solid Earth, ocean, land surfaces and atmosphere):

- **FORM@TER**: solid Earth
- **ODATIS**: oceans
- **THEIA**: land surfaces
- **AERIS**: atmosphere

Each cluster aims to facilitate access to satellite, airborne and in-situ (ground) data acquired and managed by research laboratories, distributed structures (universe science observatories (OSUs), research federations (FRs), etc.) or national infrastructures such as the national observation services (SNOs), environmental research observation and experimentation systems (SOEREs), the French oceanographic fleet, airplanes and space missions. They combine scientific disciplines related to a terrestrial compartment, offer value-added services and products, provide scientific expertise, and promote tools and methods developed within the relevant French scientific research community.

These four data clusters are grouped in the Earth System Research Infrastructure (RI), called Data Terra. The Data Terra RI features in the research infrastructure roadmap of the Ministry of Higher Education, Research and Innovation ([Research Infrastructure Roadmap 2021](#)).



Data Terra's main mission is to develop a structure for accessing and processing data, products and services geared towards observing, understanding and predicting in an integrated manner the history, mechanisms and evolution of the Earth system in response to global changes. While aimed chiefly at the scientific community, it also serves public and socio-economic stakeholders and its multi-source data are accessible via coherent, one-stop portals. As a digital infrastructure in the field of environmental science, Data Terra works closely with Earth-observation research infrastructures and space agencies. It is backed by a continuum of distributed

and interconnected platforms, proposing services that span the full data cycle from access to value-added processing, thus enabling cross-correlation, exploitation of large volumes of data—notably satellite data—and generation of information on demand combining multi-source, multi-disciplinary products. At national, European and international levels, it is advancing the development of open science, implementation of FAIR (Findable, Accessible, Interoperable, Reusable) approaches, contributing to space missions and applications and to the initiative to generate digital twins of the Earth.



The Data Terra research infrastructure offers services relating to Earth system data. Its objective is to deliver services that are interoperable and inter-disciplinary at all levels.

The Data Terra Research Infrastructure groups the four Earth System Observation Data Clusters: Oceans (ODATIS), Land Surfaces (THEIA), Atmosphere (AERIS) and Solid Earth (FORMATER).



**SPACE STUDIES OF THE
EARTH-MOON SYSTEM,
PLANETS, AND
SMALL BODIES OF
THE SOLAR SYSTEM**

© GettyImages

[Author: F.ROCARD]
Solar System Programme Manager

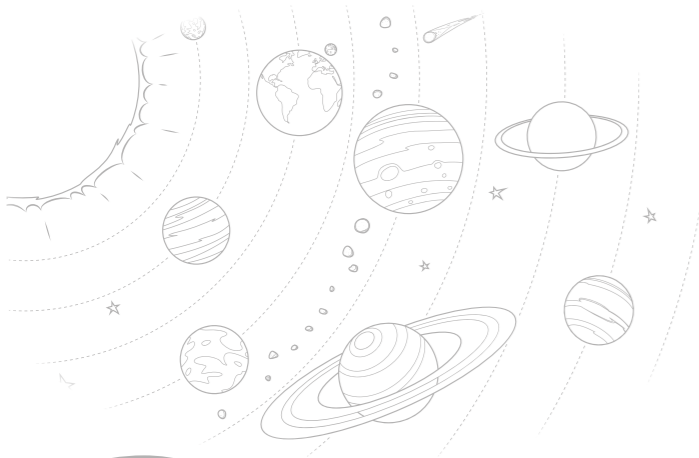

2 SPACE STUDIES OF THE EARTH-MOON SYSTEM, PLANETS, AND SMALL BODIES OF THE SOLAR SYSTEM

Beyond DORN on Chang'e 6 with CNSA and SEIS on InSight with NASA (see below), CNES is participating in numerous solar system exploration missions. CNES is significantly involved in the JUICE mission to be launched next year, an ESA mission to study Jupiter's icy moons, Ganymede, Europa and Callisto. MAJIS is an infrared mapping spectrometer under the responsibility of IAS that will study the mineralogical composition of the surfaces of the icy moons and Jupiter's atmosphere. France is also involved at different levels on the overall payload and contributing technically to PEP, RIME, RPWI, SWI and UVS.

On the ESA-JAXA BepiColombo mission that will arrive at Mercury at the end of 2025, France has the leadership on the PHEBUS ultraviolet spectrometer, for which the PI is at LATMOS (atmospheres, environments and space observations laboratory). French scientists are also contributing to Simbio-Sys and SERENA on ESA's MPO planetary orbiter MPO and providing sensors on MPE and PWI of the MIA Japanese magnetospheric orbiter.

On Mars, France is also contributing to the SuperCam chemical camera on Perseverance and on ChemCam and SAM on Curiosity. On JAXA's MMX mission that plans to bring back samples from Mars' moon Phobos, France is responsible for the MIRS IR mapping spectrometer and jointly with DLR for the rover that will scout on the surface of Phobos. Our involvement in Venus exploration is focused on the VenSpec-U UV spectrometer and Radioscience investigation of the ESA EnVision mission, for which French scientists are responsible, and we are contributing to the VenSpec-M, NIR mapping spectrometer. On the NASA VERITAS mission, we are contributing to the VEM spectrometer and providing the K_a -band transponders. We are also developing with IKI the VIRAL spectrometer that will fly on the Indian Venus orbiter mission.

On the Moon, we are providing the VBB seismometer to be integrated in the JPL FSS (Farside Seismic Suite) autonomous package that will fly on a CLPS in 2024. We are also supplying the CMOS cameras for the Emirati Rashid rover that will operate on the lunar surface this fall.

[Author: F.ROCARD]
Solar System Programme Manager

/ INSIGHT

InSight is a NASA-led Discovery mission that landed in November 2018 in the Elysium Planitia lowland region south west of the large volcano Elysium Mons. InSight is carrying SEIS, the ultra-sensitive very broad band seismometer built by CNES and the IGP Earth physics institute in Paris. For more than four years, SEIS has recorded the tiny movements of the Martian surface. More than 1,000 events have been recorded, the most significant having a magnitude of 4.

Analysis of these signals has led for the first time to the determination of the internal structure of Mars:

a large liquid core with a radius of $1,830 \pm 40$ km, and a low density meaning that it is composed of iron and nickel plus other light elements. The crust has a thickness of 20-35 km with an altered region in the first 10 km. SEIS has been able to determine the heat flux at $14-29$ mW/m², which is quite a low value. Globally, seismic activity on Mars falls somewhere between that on Earth and the Moon, and the Cerberus Fossae region is particularly active. Recently impact events due to meteorites have been detected. Due to the accumulation of dust on the solar panels, the mission may terminate before the end of this year.

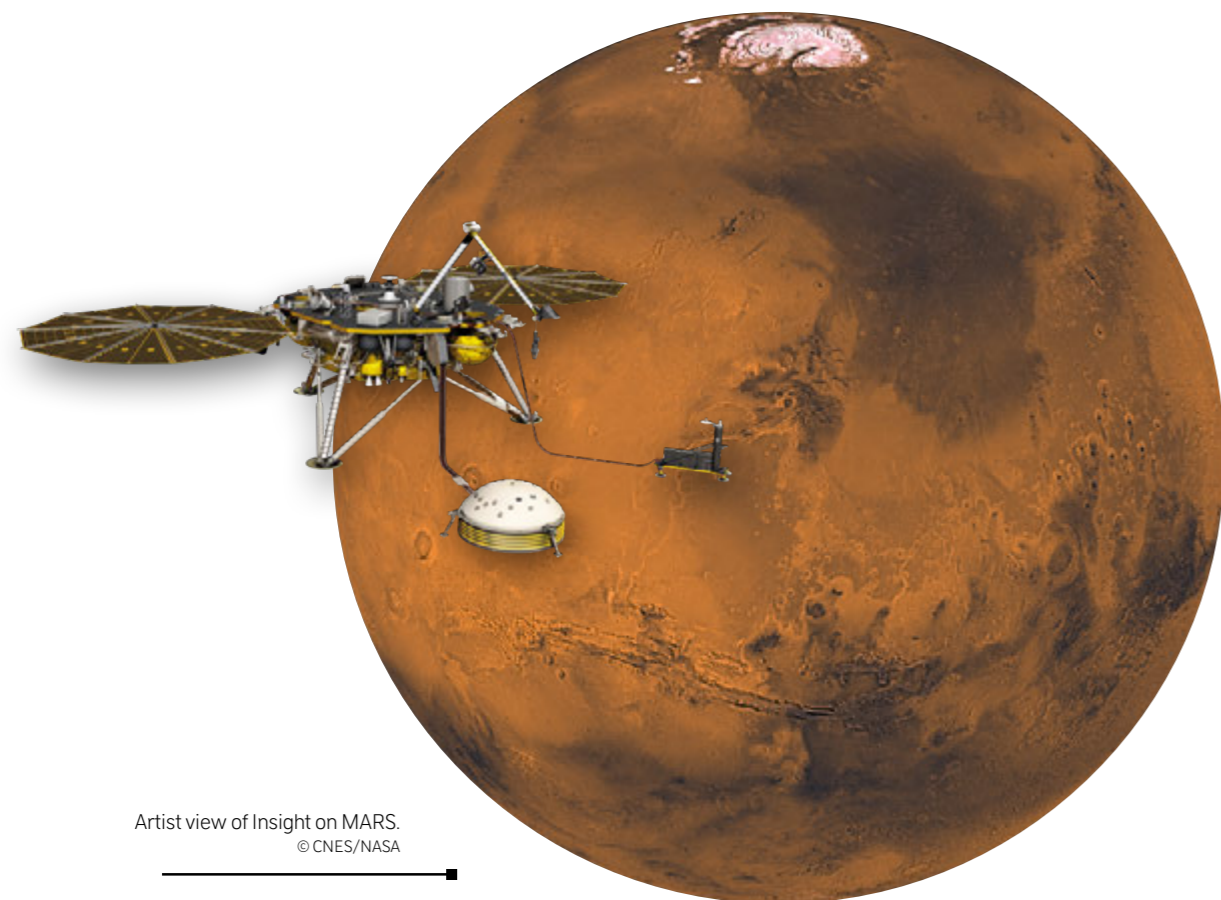

Artist view of InSight on MARS.
© CNES/NASA

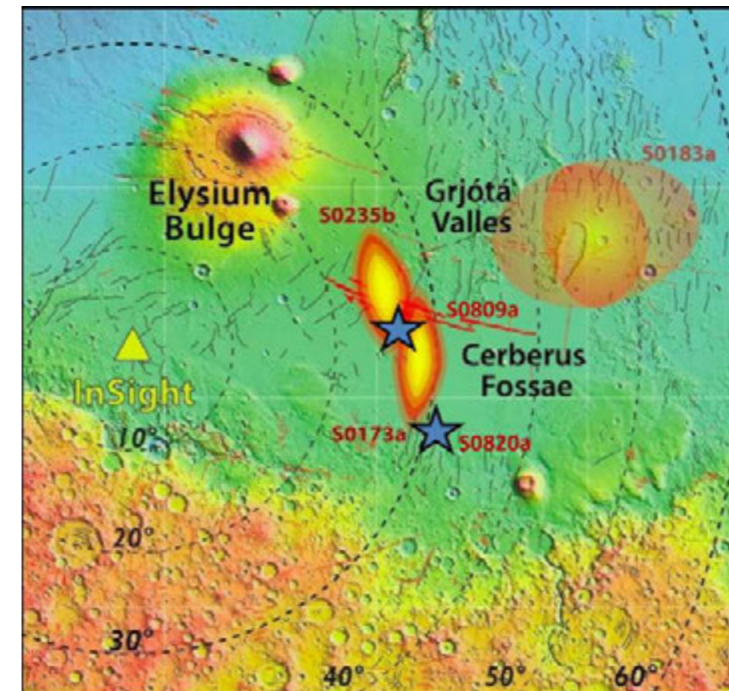

Location of events around InSight.
Cerberus Fossae is the most active seismic region.
© NASA/JPL/IPGP

Magnitude of events versus distance to SEIS instrument (in degrees). The number of the largest events referred to the day (sol) of the detection.
© NASA/JPL/IPGP

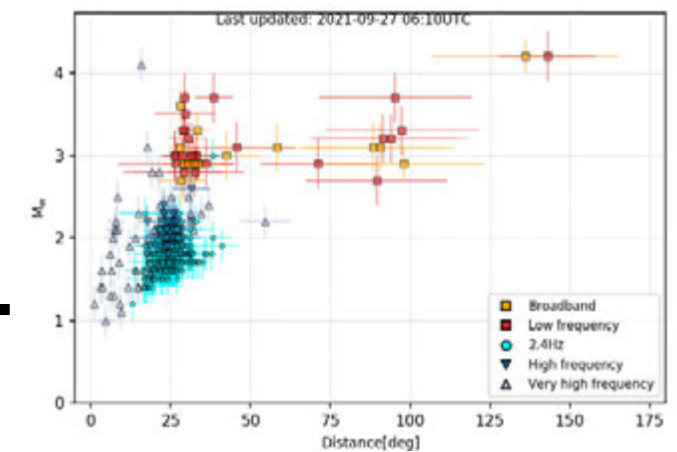

REFERENCES

S. C. Stähler, A. Khan, W. B. Banerdt, P. Lognonné, D. Giardini, S. Ceylan, M. Drilleau, A. C. Durán, R. F. Garcia, Q. Huang, D. Kim, V. Lekic, H. Samuel, M. Schimmel, N. Schmerr, D. Sollberger, É. Stutzmann, Z. Xu, D. Antonangeli, C. Charalambous, P. M. Davis, J. C. E. Irving, T. Kawamura, M. Knapmeyer, R. Maguire, A. G. Marusiak, M. P. Panning, C. Perrin, A.-C. Plesa, A. Rivoldini, C. Schmelzbach, G. Zenhäusern, É. Beucler, J. Clinton, N. Dahmen, M. van Driel, T. Gudkova, A. Horleston, W. T. Pike, M. Plasman, S. E. Smrekar, Seismic detection of the martian core, *Science*, 373, 443-448, 2021, <https://doi.org/10.1126/science.abi7730>

Khan, A., S. Ceylan, M. van Driel, D. Giardini, P. Lognonné, H. Samuel, N. C. Schmerr, S. C. Stähler, A. C. Durán, Q. Huang, D. Kim, A. Broquet, C. Charalambous, J. F. Clinton, P. M. Davis, M. Drilleau, F. Karakostas, V. Lekić, S. M. McLennan, R. R. Maguire, C. Michaut, M. P. Panning, W. T. Pike, B. Pinot, M. Plasman, J.-R. Scholz, R. Widmer-Schmidrig, T. Spohn, S. E. Smrekar, W. B. Banerdt, Upper mantle structure of Mars from InSight seismic data, *Science*, 373, 434-438, 2021, <https://doi.org/10.1126/science.abf2966>

Knapmeyer-Endrun, B., M. P. Panning, F. Bissig, R. Joshi, A. Khan, D. Kim, V. Lekić, B. Tauzin, S. Tharimena, M. Plasman, N. Compaire, R. F. Garcia, L. Margerin, M. Schimmel, É. Stutzmann, N. Schmerr, E. Bozdağ, A.-C. Plesa, M. A. Wieczorek, A. Broquet, D. Antonangeli, S. M. McLennan, H. Samuel, C. Michaut, L. Pan, S. E. Smrekar, C. L. Johnson, N. Brinkman, A. Mittelholz, A. Rivoldini, P. M. Davis, P. Lognonné, B. Pinot, J.-R. Scholz, S. Stähler, M. Knapmeyer, M. van Driel, D. Giardini, W. B. Banerdt, Thickness and structure of the martian crust from InSight seismic data, *Science*, 373, 438-443, 2021, <https://doi.org/10.1126/science.abf8966>

[Author: F.ROCARD]
Solar System Programme Manager

// DORN on CHANG'E 6

The IRAP astrophysics and planetology research institute is currently building the DORN experiment, with the support of CNES. **DORN (Detection of Outgassing Radon)** aims to measure ²²²Rn, ²²⁰Rn and their progeny at the surface of the Moon by alpha spectroscopy in the 5–10 MeV energy range.

DORN's science objectives are:

- 1) Study lunar outgassing and transport of gases through the lunar regolith; Is the release of radon mostly continuous or due to sporadic venting from the lunar interior? Constrain the transport/structural properties of the regolith;

- 2) Study the transport of volatiles in the lunar exosphere; Constrain the rate of diffusion of radon in the lunar exosphere: benchmark tracers for other gases;
- 3) Study the efficiency of the transport of lunar dust; Surface churning rate over several decades;
- 4) Improve uranium mapping of the Moon;
- 5) Establish ground truth for orbital measurements (Apollo 15-16, Lunar Prospector, Kaguya). DORN will be on board the CNSA Chang'e 6 lunar sample return mission to be launched mid-2024.

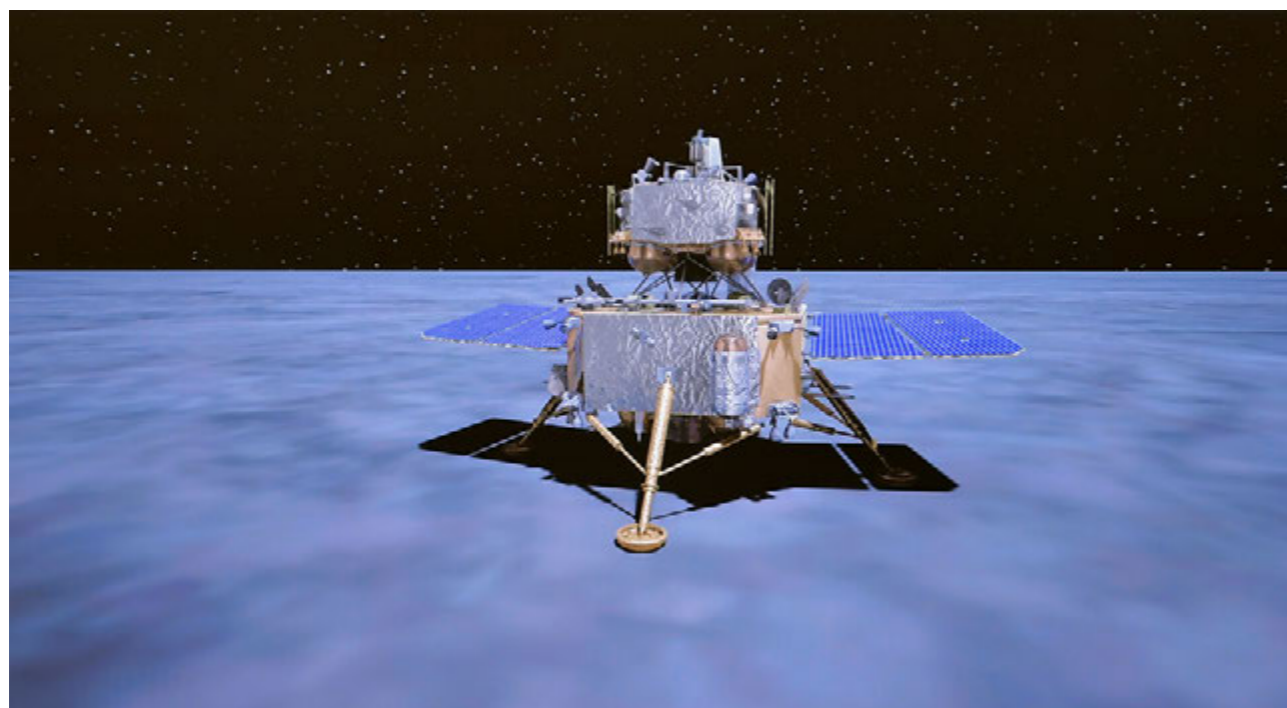

DORN on the Chang'e 6 lander.
© CNRS/IRAP/CNSA

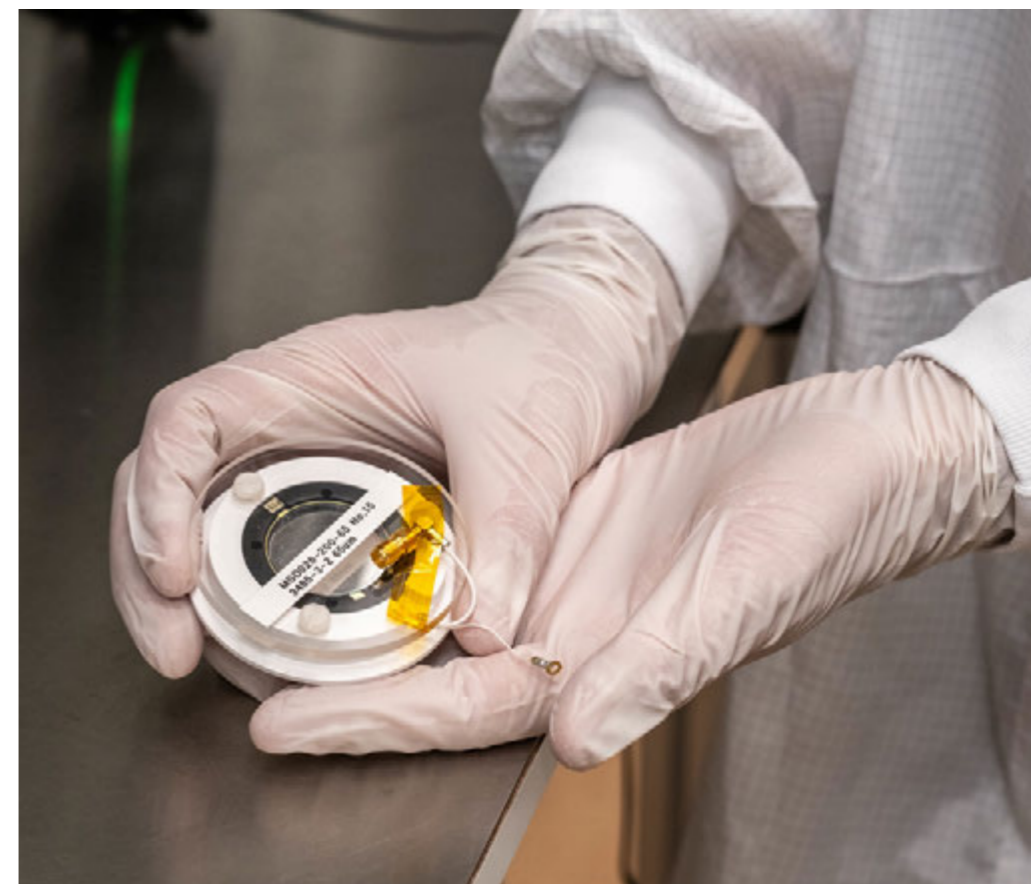

Prototype silicon detector for the DORN instrument.
© CNES/Thierry de Prada, 2021

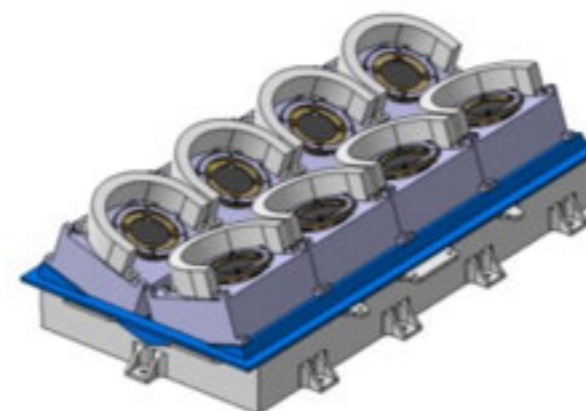

DORN design with 8 silicon detectors.
© CNRS/IRAP

REFERENCES

P.Y. Meslin, H. He, Z. Kang, R. Wimmer-Schweingruber, J.C. Sabroux, J.-F. Pineau, N. Yamashita, B. Sabot, S. Pierre, M. Blanc, J.-P. Roques, I. Plotnikov, S. Maurice, O. Gasnault, J. Amestoy, P. Pinet, O. Forni, J. Lasue, A. Guertin, V. Métyvier, N. Michel, N. Servagent, F. Haddad, F. Poirier, C. Koumeir, J. Flahaut, F. Rocard, A. Debus, K.W. Wong, P. Devoto, L. Lavergne, R. Mathon, D. Rambaud, E. Carrié, B. Dubois, N. Striebig, M. Belot, RADON AND POLONIUM AS TRACERS OF LUNAR OUTGASSING, VOLATILES AND DUST: GOING BACK TO THE MOON?, 51st Lunar and Planetary Science Conference (2020) 1741.pdf

[Author: C.MUSTIN]
 Scientific expert for exobiology,
 exoplanets and planetary protection

/// EXOMARS 2022

Context

Determining whether life forms, similar or not to those known on Earth, could have appeared and developed on Mars is one of the most important scientific questions to which space exploration provides answers by combining in-situ analyses, observations from orbit and laboratory experiments. For many years now, CNES has been guiding and supporting the research communities in exobiology and space mission programmes aiming to address these important scientific objectives.

The ExoMars programme is a prime example of integrating these scientific objectives into an exploration mission that also aims to demonstrate key technologies for landing and mobility on the Red Planet. Since 2012, ExoMars has been an ambitious technology and cooperation programme between the European Space Agency (ESA) and the Russian federal space agency (Roscosmos) to work in partnership to develop and launch two missions in 2016 and 2018. Their main scientific objectives are respectively (i) to study trace gases (methane, water vapour) in the

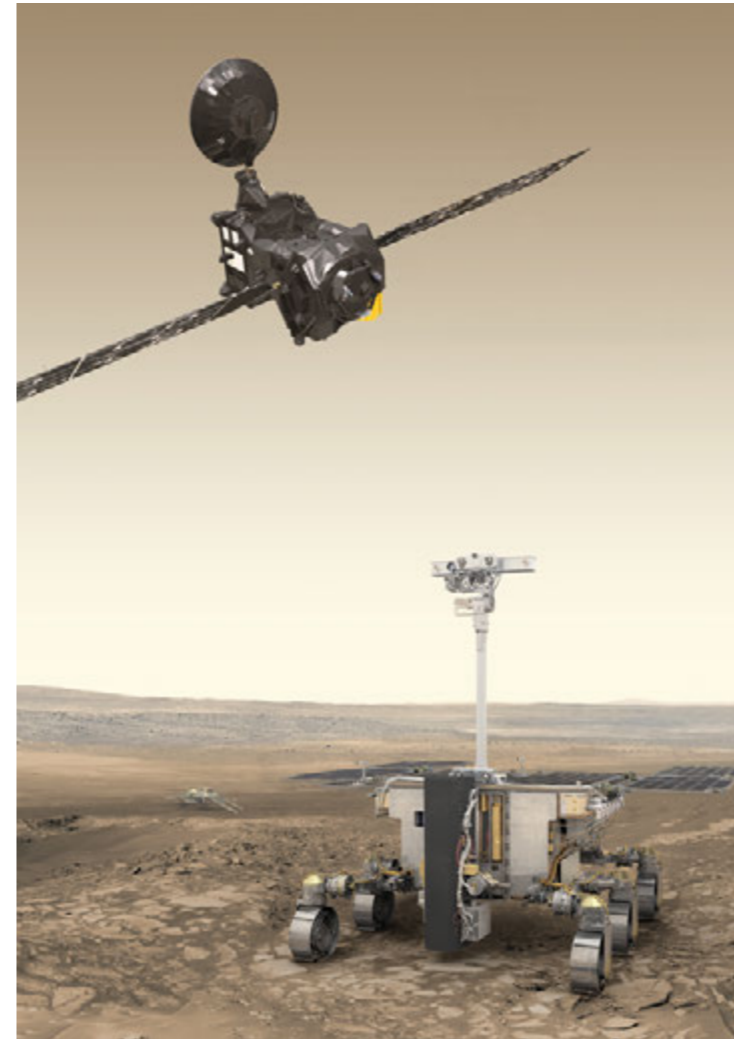

ExoMars orbiter and rover.
 © ESA/ATG Medialab

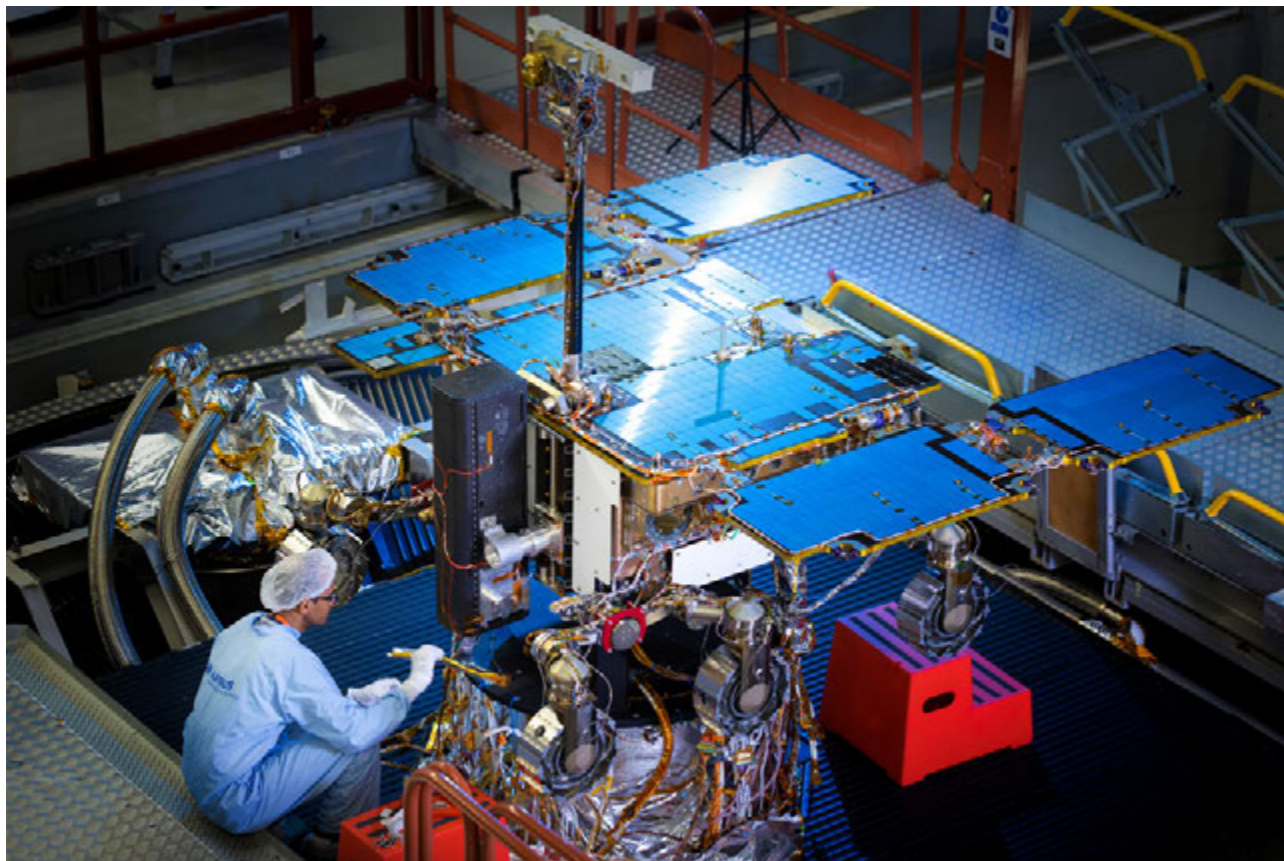

Testing the ExoMars mission rover at Intespace.
 © CNES/Gwenewan Le Bras, 2018

ExoMars 2022 – Status

With a surface platform, Kazachok, instrumented to perform environmental and geophysics measurements, and a 300-kg rover, Rosalind Franklin, to collect and analyse well-preserved mineral and organic matter in the subsurface, ExoMars 2022 is a unique mission to probe the very early history of Mars and yield precious information regarding water-rich environments, prebiotic chemistry and perhaps emergence of Martian life. If robust signs of biosignatures are discovered, this mission will fix what types of samples we should preferentially return to Earth for further study. To date, the consortium of European, American and Russian scientists, space agency engineers and industries have done excellent work developing the two platforms and mission operations. The French instrument contributions as PI (WISDOM, a ground-penetrating radar; MicrOmega, an infrared imaging spectrometer) or Co-I (CLUPI, a close-up imager; RLS, a Raman spectrometer; and MOMA, a laser-desorption, thermal-volatilization, derivatization, gas chromatograph mass spectrometer) have been successfully completed. The French science teams, including also a French Interdisciplinary Scientist (IDS) and Guest Investigator (GI) appointed by ESA, are ready to undertake the challenges of operating Rosalind Franklin on Mars.

Martian atmosphere and to identify their sources on the surface, and (ii) to characterize the subsurface environment to search for signs of past and present life on Mars. The first ExoMars 2016 mission with the Trace Gas Orbiter (TGO) was launched as planned in 2016, while the second had to be postponed to 2022, initially due to implementation delays and later because of the CoVID-19 pandemic. However, due to the unexpected conflict in Ukraine, ESA Member States unanimously decided in March to suspend activities with Roscosmos on ExoMars 2022 and determine the options available to implement this part of the mission.

TGO – Key research findings

After a long atmospheric aerobraking phase until March 2018, TGO nominal science operations began in May 2018 with three instruments involving French scientists for the detection of atmospheric trace gases (NOMAD and ACS) and Martian surface imaging at a pixel resolution of 4.6 metres (CaSSIS).

In spite of their sensitivity (1,000 to 10,000 times higher than instruments on previous missions), TGO observations using the NOMAD and ACS instruments have not detected atmospheric methane at the altitudes they can explore using the Sun occultation technique (typically between 5 and 25 km) down to a minimum detection limit of ~0.01 ppbv [11]. This is in contradiction with reports from Curiosity's team, who claim to have measured in-situ levels between 0.2–0.8 ppbv as continuous background and more during putative peak emissions. This difference remains to be explained. Another important finding of TGO has been the role that atmospheric heating and subsequent inflation during large dust storms has on boosting atmospheric and especially water vapour escape [12, 13].

To date, the CaSSIS camera on TGO has obtained more than 10,000 colour images of the Martian surface, many of which are stereo pairs (~2,000). This camera helps

to identify Martian sites as potential sources of gas emissions detected by ACS and investigate dynamic surface processes (wind, sublimation, etc.). Thus, CaSSIS is advancing understanding of Mars' hydrological and atmospheric cycles. In particular coupled with HiRISE data, CaSSIS observations are very useful for constraining the involvement of liquid water in recurring slope lineae (RSL) on Mars. The instrument will also be valuable for characterizing potential sites for future in-situ missions (ExoMars 2022 will be rescheduled), in particular due to its stereoscopic capability which is useful for characterizing topography [14].

TGO will continue its science and data relay mission. The next challenge is to launch, land, and perform ExoMars 2022. Beyond this, NASA and ESA are working together on the Mars Sample Return mission planned for 2028-2033.

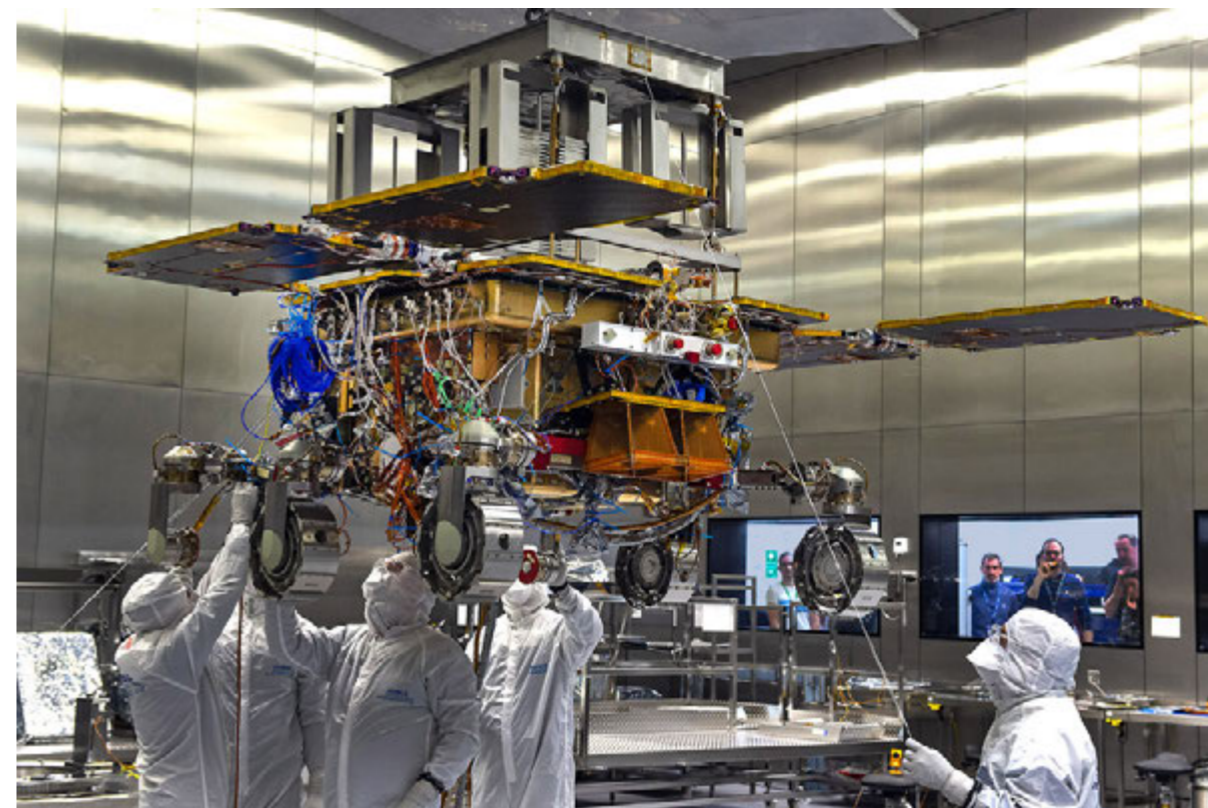

ExoMars rover.
© Max-Alexander-Airbus

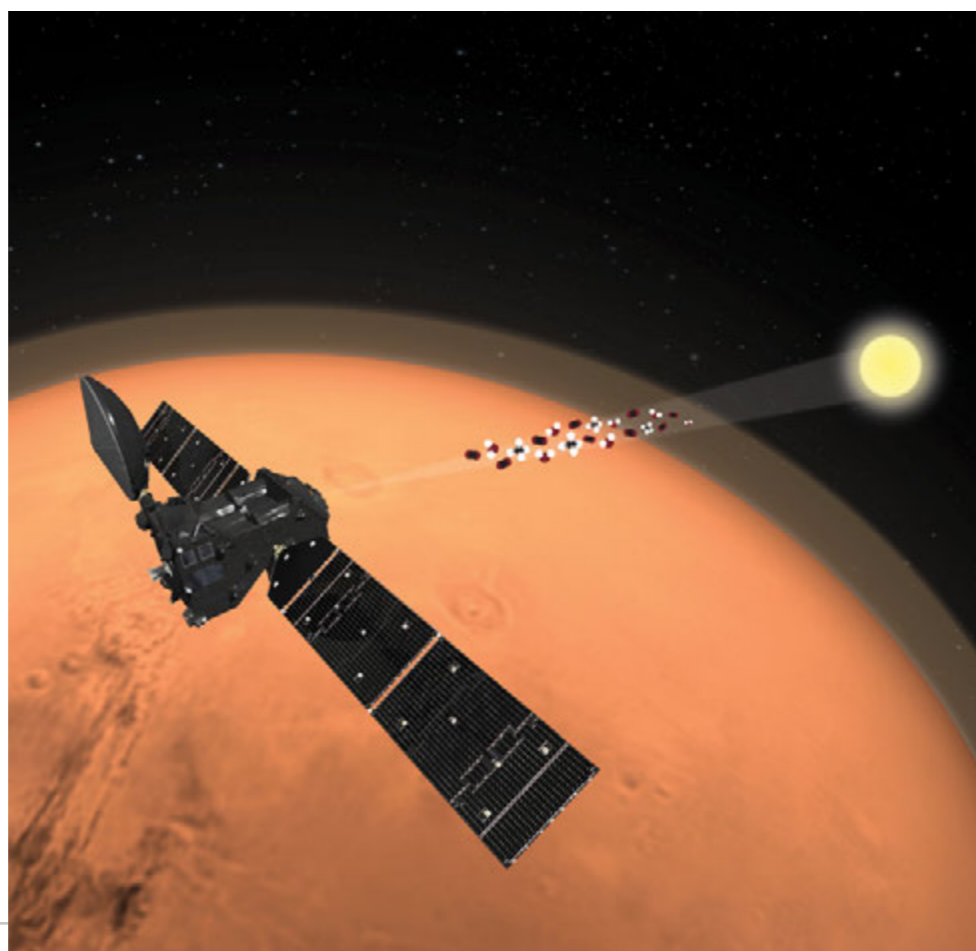

Artist's impression of the ExoMars Trace Gas Orbiter (TGO).
© ESA/ATG Medialab

REFERENCES

- [1] Korablev, O.; Vandaele, A. C.; Montmessin, F.; Fedorova, A. A.; Trokhimovskiy, A.; Forget, F.; Lefèvre, F.; Daerden, F.; Thomas, I. R.; Trompet, L.; Erwin, J. T.; Aoki, S.; Robert, S.; Neary, L.; Viscardy, S.; Grigoriev, A. V.; Ignatiev, N. I.; Shakun, A.; Patrakee, A.; Belyaev, D. A.; Bertaux, J.-L.; Olsen, K. S.; Baggio, L.; Alday, J.; Ivanov, Y. S.; Ristic, B.; Mason, J.; Willame, Y.; Depiesse, C.; Hetey, L.; Berkenbosch, S.; Clairquin, R.; Queirolo, C.; Beeckman, B.; Neefs, E.; Patel, M. R.; Bellucci, G.; López-Moreno, J.-J.; Wilson, C. F.; Etiopie, G.; Zelenyi, L.; Svedhem, H.; Vago, J. L., & The ACS and NOMAD Team. (2019). No detection of methane on Mars from early ExoMars Trace Gas Orbiter observations, *Nature*, 568: 517-520, <http://dx.doi.org/10.1038/s41586-019-1096-4>
- [2] Vandaele, A. C.; Korablev, O.; Daerden, F.; Aoki, S.; Thomas, I. R.; Altieri, F.; López-Valverde, M.; Villanueva, G.; Liuzzi, G.; Smith, M. D.; Erwin, J. T.; Trompet, L.; Fedorova, A. A.; Montmessin, F.; Trokhimovskiy, A.; Belyaev, D. A.; Ignatiev, N. I.; Luginin, M.; Olsen, K. S.; Baggio, L.; Alday, J.; Bertaux, J.-L.; Betsis, D.; Bolsée, D.; Clancy, R. T.; Cloutis, E.; Depiesse, C.; Funke, B.; Garcia-Comas, M.; Gérard, J.-C.; Giuranna, M.; Gonzalez-Galindo, F.; Grigoriev, A. V.; Ivanov, Y. S.; Kaminski, J.; Karatekin, O.; Lefèvre, F.; Lewis, S.; López-Puertas, M.; Mahieux, A.; Maslov, I.; Mason, J.; Mumma, M. J.; Neary, L.; Neefs, E.; Patrakee, A.; Patsaev, D.; Ristic, B.; Robert, S.; Schmidt, F.; Shakun, A.; Teanby, N. A.; Viscardy, S.; Willame, Y.; Whiteway, J.; Wilquet, V.; Wolff, M. J.; Bellucci, G.; Patel, M. R.; López-Moreno, J.-J.; Forget, F.; Wilson, C. F.; Svedhem, H.; Vago, J. L. & Nomad Science Team and ACS Science Team (2019). Martian dust storm impact on atmospheric H₂O and D/H observed by ExoMars Trace Gas Orbiter, *Nature*, 568: 521-525, <http://dx.doi.org/10.1038/s41586-019-1097-3>
- [3] Munaretto, G., Pajola, M., Cremonese, G., Re, C., Alice Lucchetti, A., Simioni, E., McEwen, A., Pommerol, A., Becerra, P., Conway, S., Thomas, N., Massironi, M. (2020). Implications for the origin and evolution of Martian recurring slope lineae at Hale crater from CaSSIS observations, *Planetary and Space Science*, 187, <http://dx.doi.org/10.1016/j.pss.2020.104947>
- [4] Fedorova, A. A., et al. (2020). Stormy water on Mars: The distribution and saturation of atmospheric water during the dusty season. *Science*, 367: 297-300, <https://www.science.org/doi/10.1126/science.aay9522>



**SPACE STUDIES OF THE
UPPER ATMOSPHERES
OF THE EARTH AND
PLANETS INCLUDING
REFERENCE
ATMOSPHERES**

© GettyImages

[Author: M.MANDEA]
Head "Science Coordination" Department

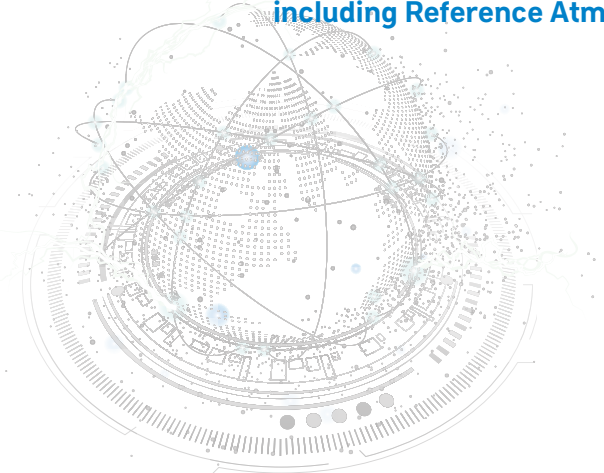

3 SPACE STUDIES OF THE UPPER ATMOSPHERES OF THE EARTH AND PLANETS INCLU- DING REFERENCE ATMOSPHERES

The main studies promoted by this commission are investigating specified aspects of the properties and structure of the upper atmospheres of the Earth and planets.



Sprite observed from Italy's
Orbetello peninsula.
© Stéphanie Vetter, 2019

CNES has made huge efforts in preparing the **TARANIS (Tool for the Analysis of Radiation from lightning and Sprites) mission**. The mission was initiated by CNES, as prime contractor and in charge of payload integration on the Myriade microsatellite bus and testing. This observation satellite would have studied transient events produced in the Earth's atmospheric layer between 10 km and 100 km altitude. This mission was mainly dedicated to the study of impulsive transfers of energy between atmosphere and space occurring above

thunderstorms. TARANIS should have delivered unique data to probe the mechanisms underlying lightning energy transfers between the atmosphere, ionosphere and magnetosphere, and assessed their possible impacts on Earth's environment. The satellite was launched in November 2020 aboard VEGA flight VV17 to be placed into a Sun-synchronous orbit at an altitude of 676 km, for a mission planned to last two to four years. Unfortunately, the rocket failed shortly after launch and the mission was lost.



Artist's impression of the TARANIS satellite.
© CNES/Olivier Sattler, 2012



Seosat satellite ready for transfer.
©CNES/ESA/Arianespace/CSG video and photo dept./ JM Guillon, 2020

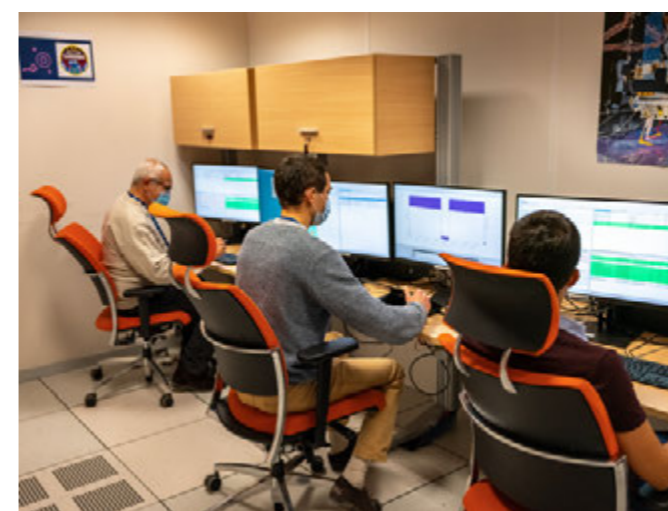

TARANISTEC.
© CNES/Thierry de Prada, 2020

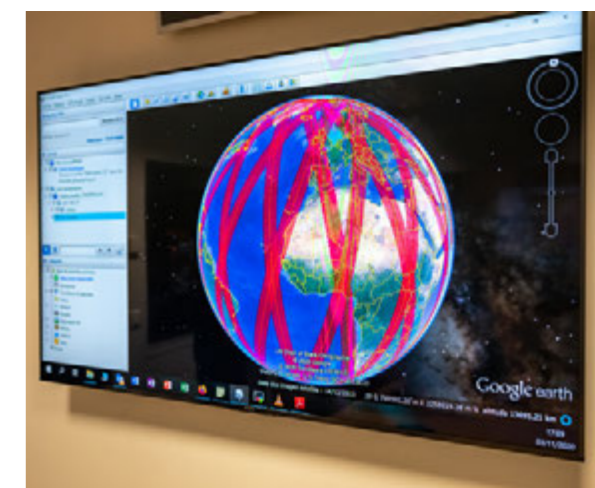

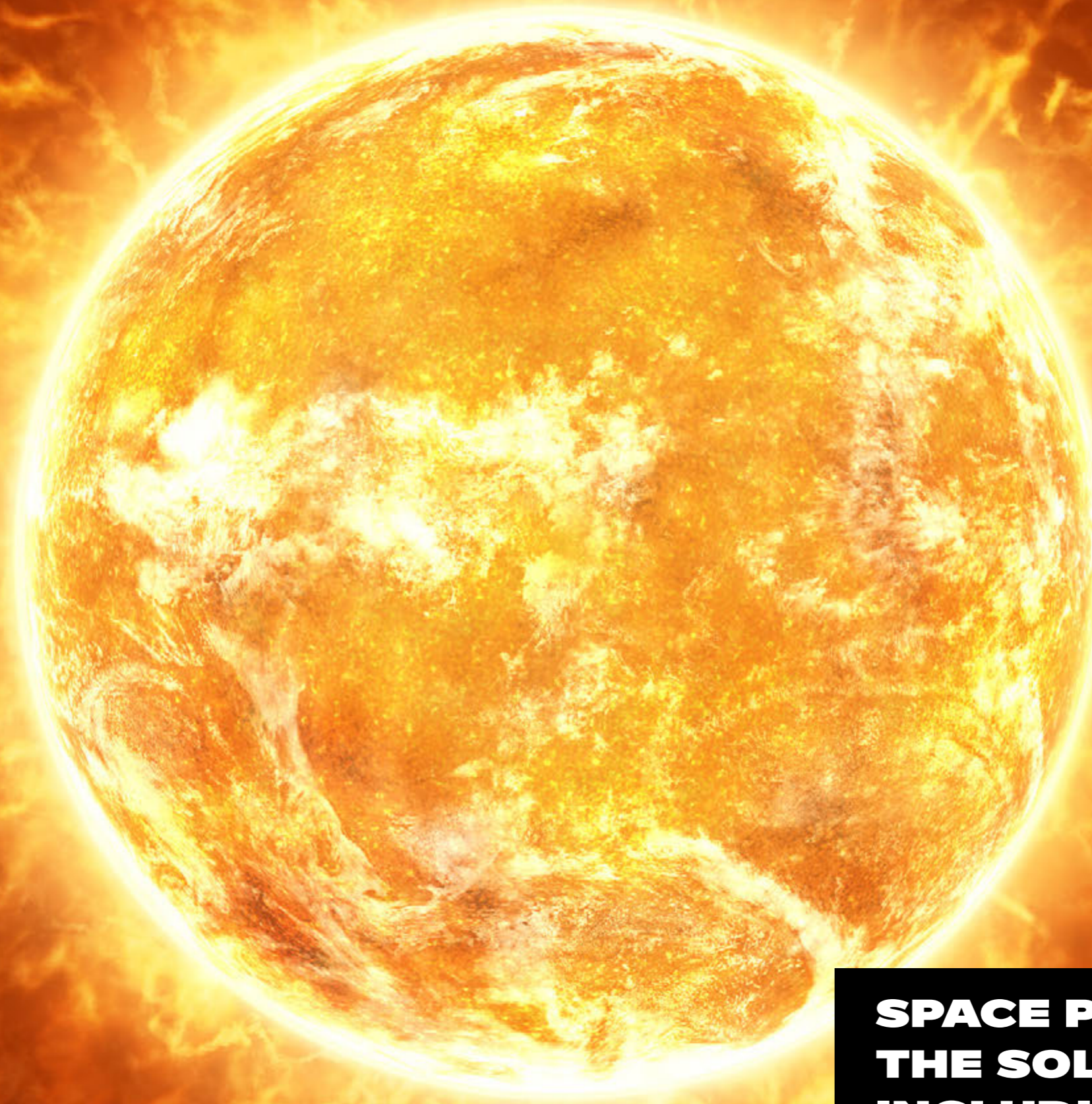

**SPACE PLASMAS IN
THE SOLAR SYSTEM,
INCLUDING PLANETARY
MAGNETOSPHERES**

© GettyImages

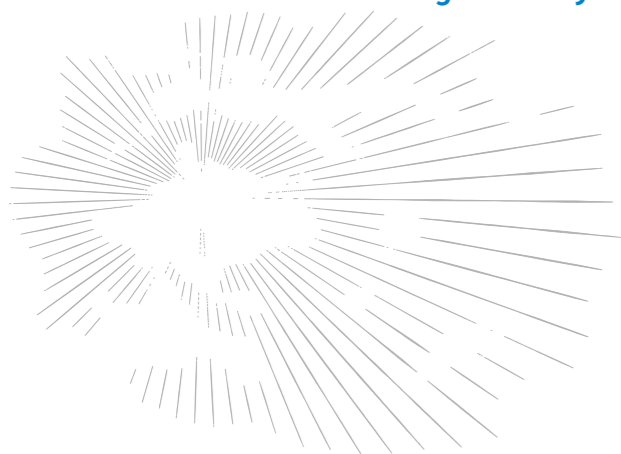

[Author: K.AMSIF]
Heliophysics Programme Manager

4 SPACE PLASMAS IN THE SOLAR SYSTEM, INCLUDING PLANETARY MAGNETOSPHERES

**French heliophysics programme:
“Sun, Heliosphere, Magnetospheres: SHM”**

The SHM community is closely involved in several projects covering the broad domain of the heliosphere, including solar physics, Earth’s magnetosphere and environment, as well as couplings between the Sun, solar wind, magnetosphere, ionosphere and thermosphere. Space meteorology is also part of this programme.



/ SOLAR ORBITER



Solar orbiter.
© ESA

Solar Orbiter is an ESA-led mission with strong NASA participation dedicated to solar physics. The spacecraft combines in-situ and remote-sensing instruments to gain new insights into the solar wind, the heliospheric magnetic field, solar energetic particles, interplanetary disturbances and the Sun’s magnetic field.

Launched on 10 February 2020, the mission will provide close-up and high-latitude observations of the Sun: A series of gravity assist manoeuvres at Venus will increase its inclination to the solar equator over time, reaching up to 33° of latitude, so the Sun can be observed from its poles.

Solar Orbiter’s cruise phase lasted until 27 November 2021. During that time, the spacecraft acquired science data of such good quality that the first results produced more than 50 papers published in a special issue of Astronomy and Astrophysics.

Among the ten instruments on board, French research laboratories and CNES were closely involved in developing five of them and provided one complete instrument, Radio & Plasma Waves (RPW). RPW acquires in-situ and remote-sensing measurements of both electrostatic and electromagnetic fields and waves in a broad frequency range.

The Full Sun Imager of the Extreme Ultraviolet Imager on board the ESA/NASA Solar Orbiter spacecraft captured a giant solar eruption on 15 February 2022.
© ESA/NASA

[Author: K.AMSIF]
Heliophysics Programme Manager

// PARKER SOLAR PROBE

The NASA Parker Solar Probe (PSP) launched in August 2018 is on a mission to approach the Sun to within 9.86 solar radii and make in-situ observations of its outer atmosphere, also called the solar corona. PSP will help to answer two of the remaining major questions in solar physics: Why is the solar corona so much hotter than the photosphere? And how is the solar wind accelerated?

Since 2018, PSP is getting closer and closer to our star. During its 10th close approach to the Sun on November 2021, it acquired observations of the corona down to 0.062 AU (13.3 solar radii), a region never observed until now. The closest approach, within 9 solar radii from the surface, is expected to arrive in 2024.

Four French laboratories and CNES are involved in two of the four instrument suites on PSP. They contributed not only to the expertise and design of some instruments, but also to the complete search coil magnetometer instrument (SCM), a sensor to measure magnetic field variations.

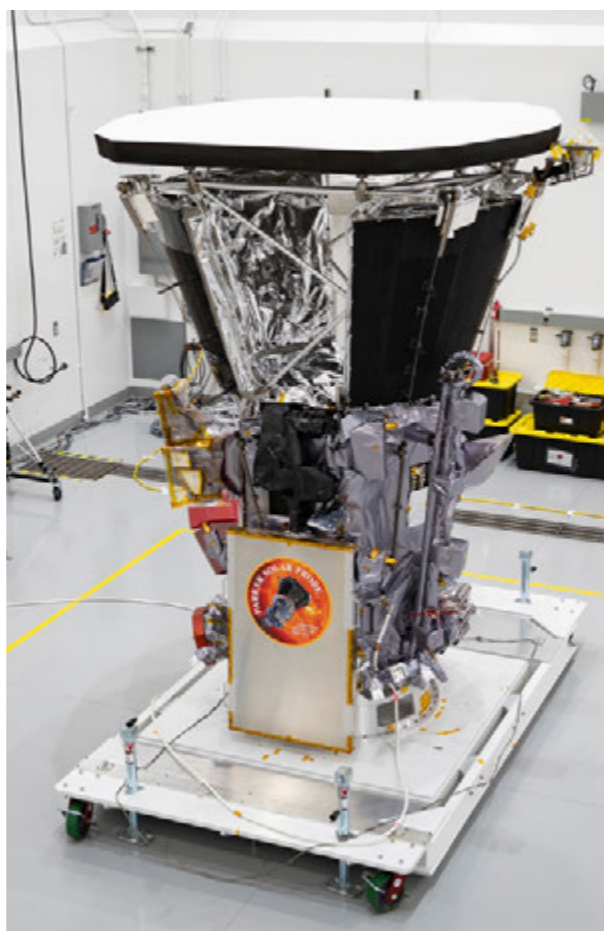

Parker Solar Probe during integration.
© NASA/ Johns Hopkins APL/WHITEMAN

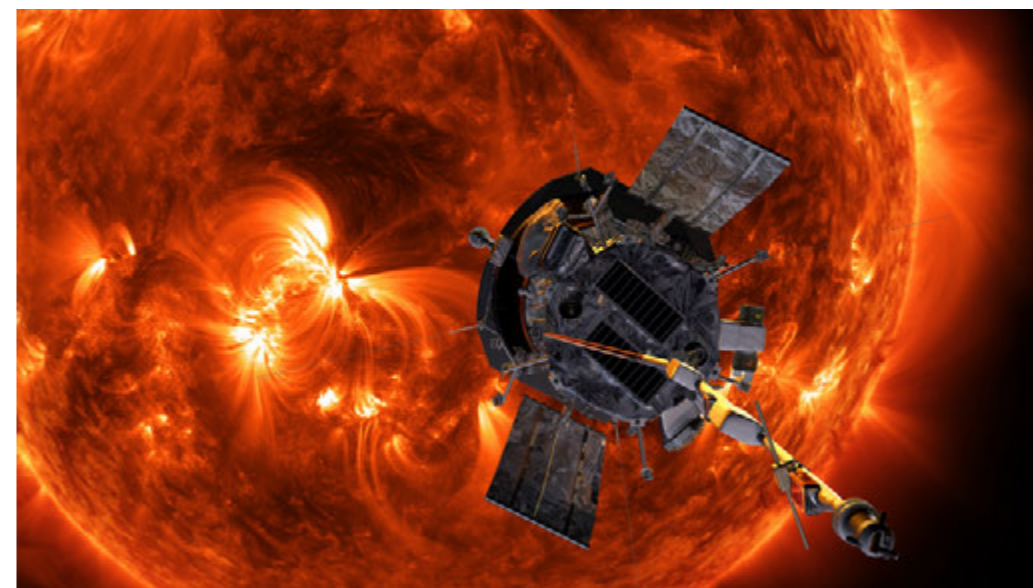

Parker Solar Probe in front of Sun.
© NASA



Solar Orbiter and
Parker Solar Probe
© NASA

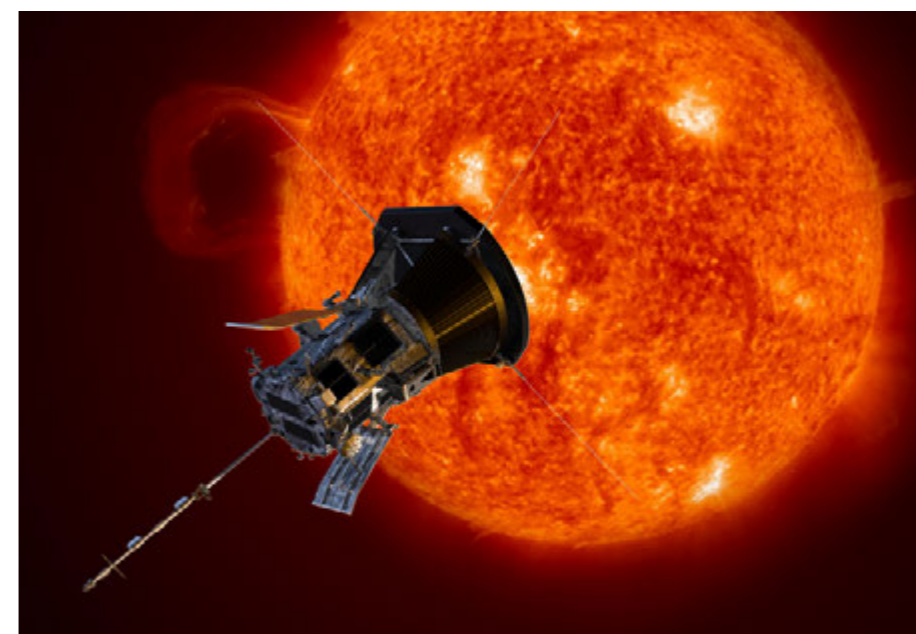

SPP observing sun.
© NASA

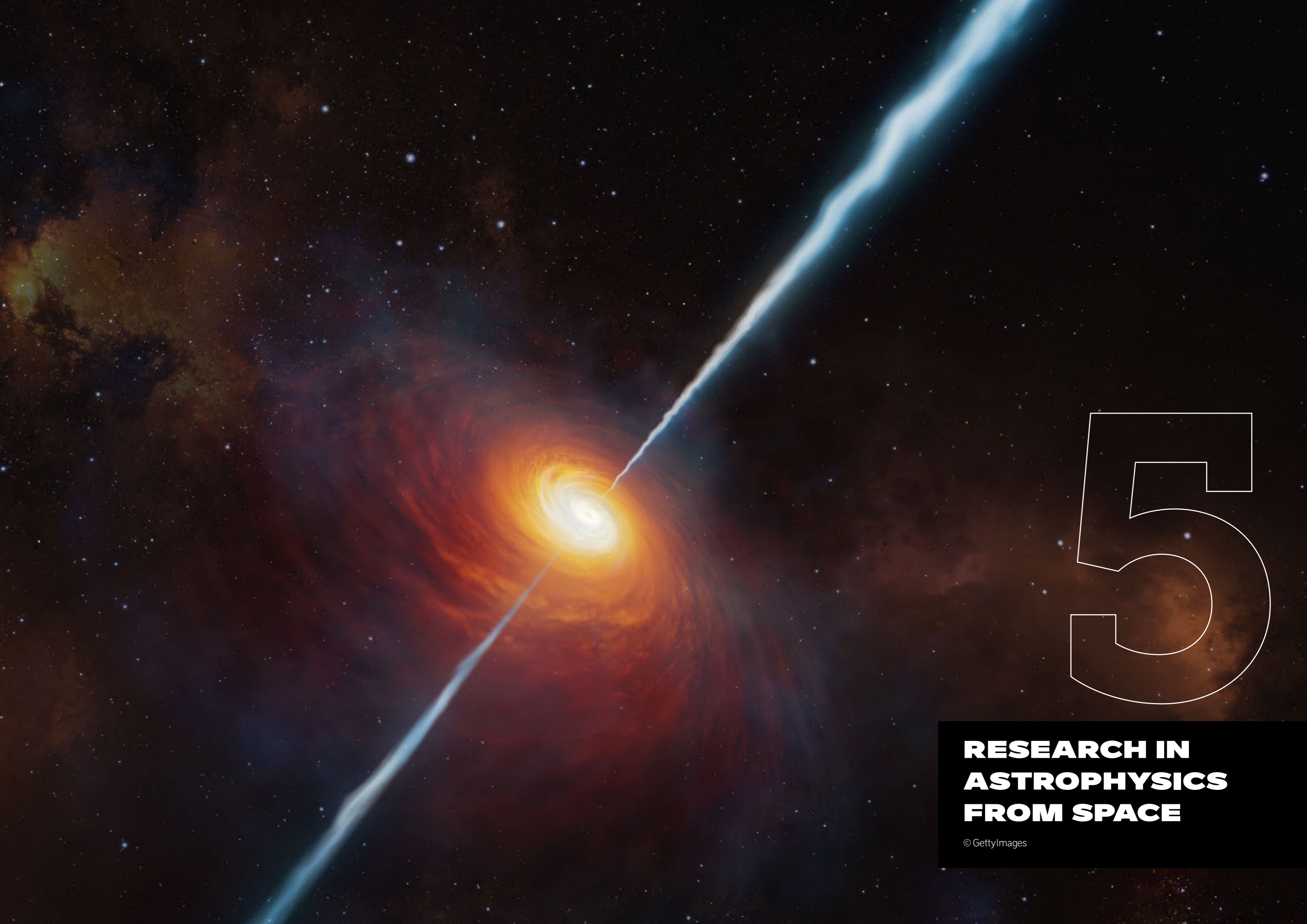

5

**RESEARCH IN
ASTROPHYSICS
FROM SPACE**

© GettyImages

[Author: O.LA MARLE]
Head of Space Science

[Author: P.LAUDET]
Astronomy & Astrophysics Programmes

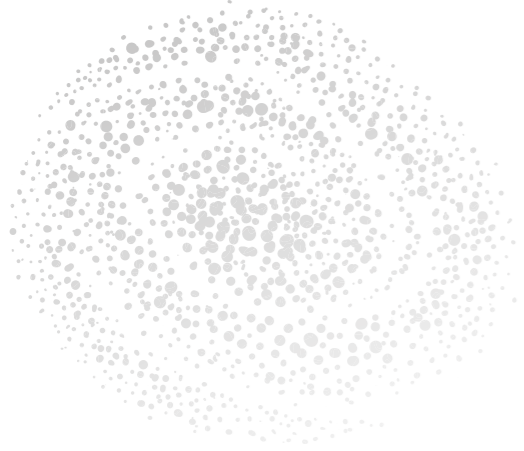

5 RESEARCH IN ASTROPHYSICS FROM SPACE

CNES is pursuing an ambitious programme in astrophysics. The main questions being addressed derive from the agency's Science Survey Seminar held in Le Havre in 2019. Understanding the origin and evolution of the universe, as well as the formation of planets and the appearance of life, are major drivers for this programme. In cooperation with research institutes and universities, the agency and its technical field centre develop space instruments for cutting-edge international astrophysics missions, and contribute to the processing of the respective data.

/ GAIA

GAIA, an ESA mission, is an ambitious mission to chart a three-dimensional map of the Milky Way, in the process revealing the composition, formation and evolution of our Galaxy. GAIA will provide unprecedented positional and radial velocity measurements with the accuracies needed to produce a stereo-

scopic and kinematic census of about one billion stars in our Galaxy and throughout the Local Group. This amounts to about 1 per cent of the Galactic stellar population.

The GAIA payload consists of three main instruments:

- The astrometry instrument (Astro) precisely determines the positions of all stars brighter than magnitude 20 by measuring their angular position.
- The photometric instrument (BP/RP) allows the acquisition of brightness measurements of stars over the 320–1,000 nm spectral band, of all stars brighter than magnitude 20.
- The Radial-Velocity Spectrometer (RVS).

Several Gaia catalogues have been released over the years, each time with more information and better astrometry; the first data release, GAIA DR1, based on only 14 months of observations, was on 14 September 2016. The second data release (DR2) came on 25 April 2018. DR3 will be published on 13 June 2022.

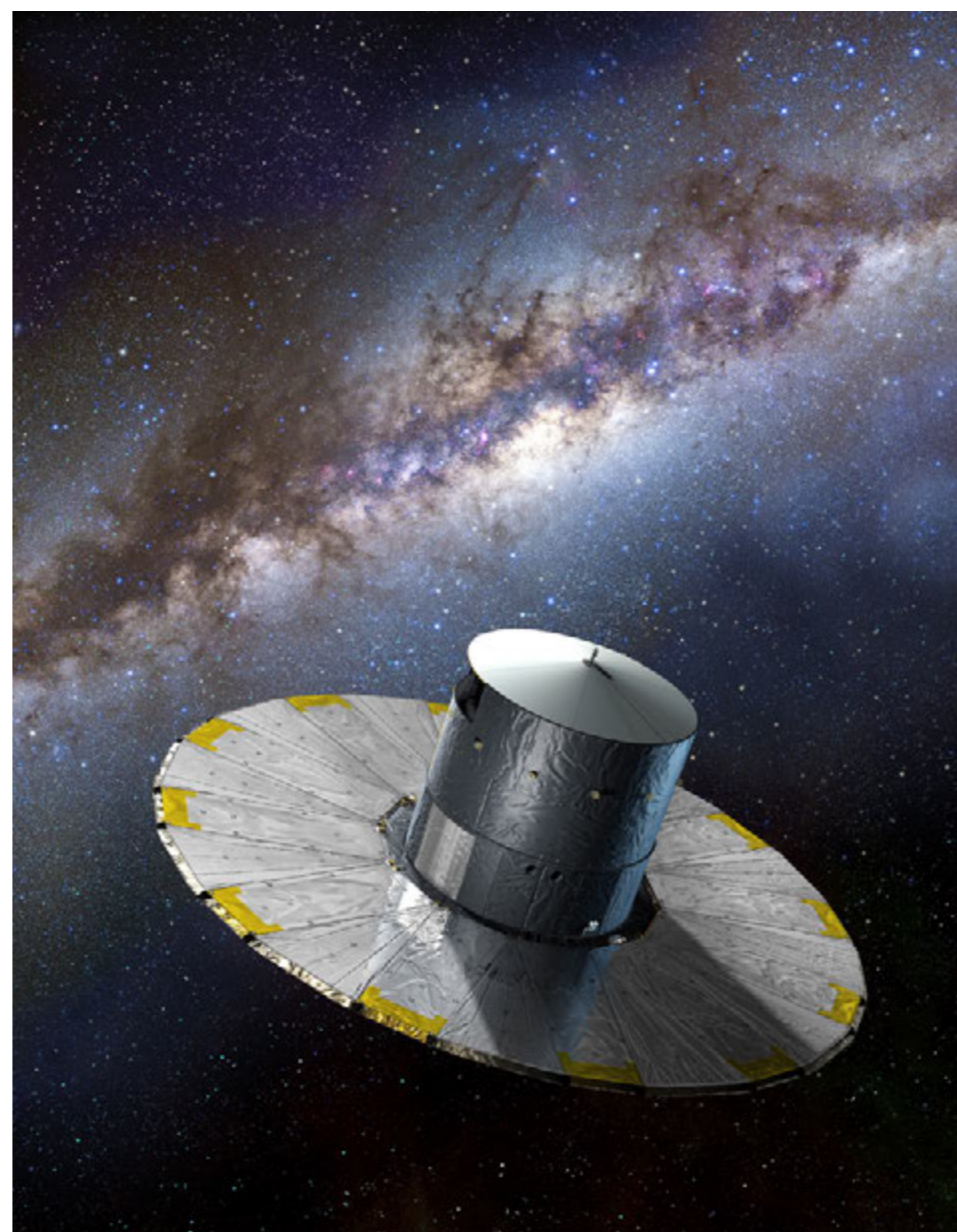

Artist's impression of the GAIA satellite.
© ESA/David Ducros, 2013

[Author: O.LA MARLE]
 Head of Space Science

// EUCLID

Euclid is the next ESA Medium-class science mission set to launch. From the L2 Lagrange point, which it should reach by mid-2023, this high-performance 1.5-metre telescope will perform a six-year survey of a large part of the sky in the visible and near-infrared spectrum. The resulting galaxy catalogue will provide high-resolution images and redshifts of billions of galaxies. Specially designed to address the dark energy question, these products will be a treasure trove for the whole astronomy community.

The Euclid consortium, with more than 1,500 scientists and engineers from three continents, developed both focal plane instruments and is in charge of the highly challenging data processing. CNES, in addition to supporting the Euclid Consortium Lead at the IAP astrophysics institute in Paris, is also responsible for the infrared spectro-photometer, for parts of the visible instrument, and for a large share of the science ground segment.

Both instruments have been delivered and integrated on the satellite, and preparation of the infrastructure and automated software for processing has passed several milestones.

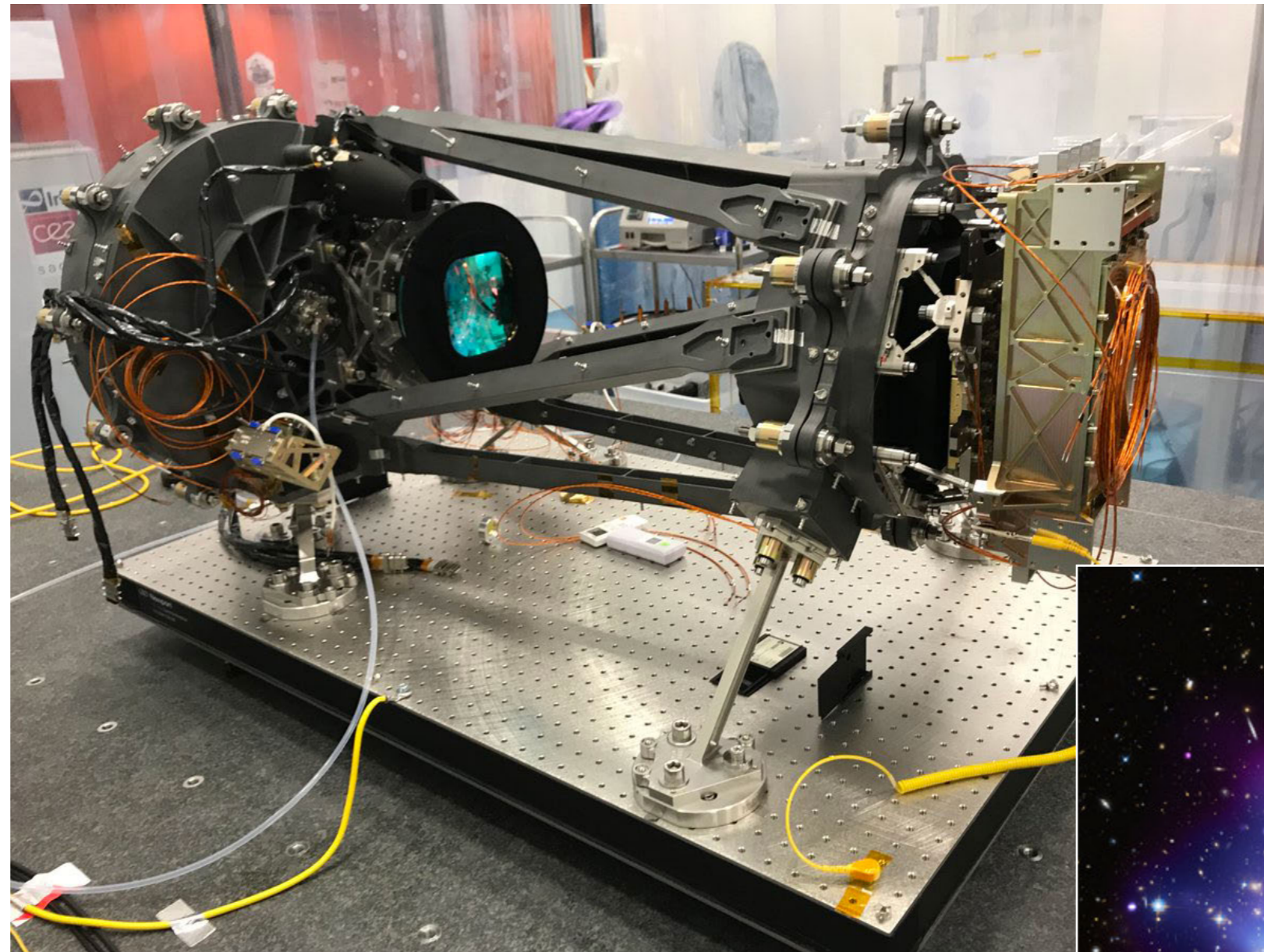

The fully assembled flight model of ESA's Euclid mission's NISP instrument in the cleanroom at the Laboratoire d'Astrophysique de Marseille (LAM) before being wrapped in Multi-Layer Insulation (MLI).
 © Euclid Consortium & NISP instrument team

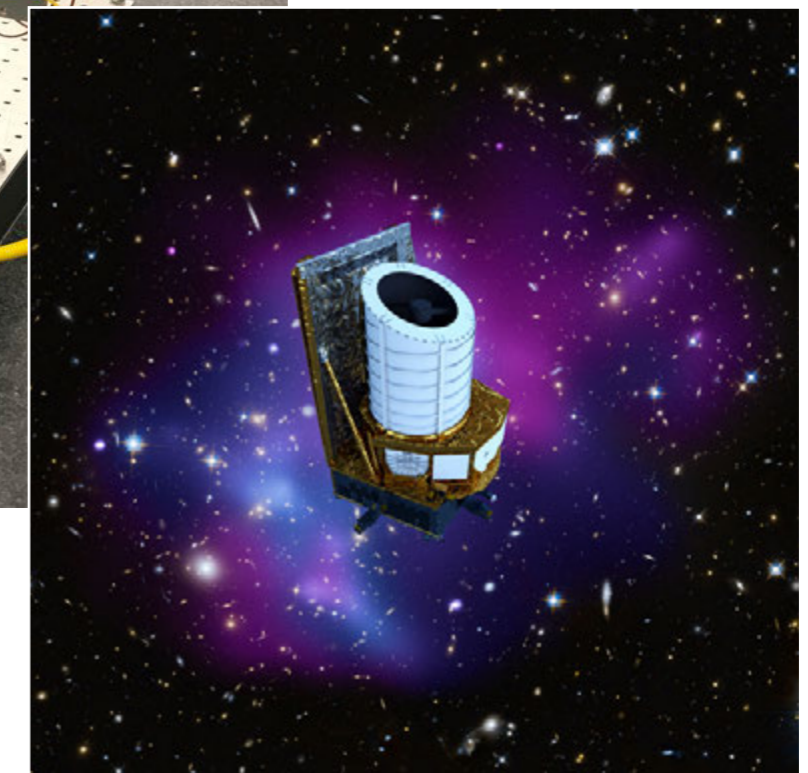

Artist's impression of the Euclid spacecraft.
 © ESA/ATG medialab (spacecraft), NASA, ESA, CXC, C. Ma, H. Ebeling and E. Barrett (University of Hawaii/IfA), et al. and STScI (background)

[Author: O.LA MARLE]

Head of Space Science

/// ATHENA

Athena is ESA's next flagship science mission.

One of the largest space-based observatories ever, this X-ray telescope will address both the unanswered questions of the aggregation of ordinary matter into large-scale structures, and the growth of black holes and their role in shaping the universe. X-ray emissions from hot gas, the bulk of ordinary matter, will be mapped and spectroscopically analysed with unprecedented accuracy by a wide-field imager and a revolutionary X-ray integral field spectrometer, named XIFU.

XIFU is being developed by an international consortium, led by the IRAP astrophysics and planetology research institute and CNES. The instrument will be the workhorse for the physical and chemical diagnostics of the hot gas that pervades large structures, of accretion disks around black holes, and of many other objects. Its focal plane populated with several thousand TES-based micro-calorimeters cooled down to 50 mK delivers exquisite spectral resolution (2.5 eV at 7 keV).

Athena is currently in phase B. The adoption of the mission is foreseen in 2023.



ATHENA.
© ESA/IRAP/CNRS/UT3/CNES/Fab&Fab

[Author: P.LAUDET]

Astronomy & Astrophysics Programmes

//// SVOM

SVOM (Space-based multi-band astronomical Variable Objects Monitor) is a French-Chinese mission dedicated to studying the most distant explosions of stars, gamma-ray bursts. It is to be launched mid-2023 by the Chinese Long March 2C rocket from the Xichang launch centre.

It is a collaboration between CNSA (China National Space Administration) and CNES (Centre National d'Etudes Spatiales), with the main instrumental contributions provided by the IRFU institute of research into the fundamental laws of the universe and the IRAP astrophysics and planetology research institute for France, and the National Astronomical Observatory (NAO) and the Beijing High Energy Institute (IHEP) for China.

Two of the four main instruments are French (ECLAIRs and MXT) and two are Chinese (GRM and VT):

- The ECLAIRs telescope to detect and locate gamma-ray bursts in the X-ray band and low-energy gamma rays (from 4 to 250 keV).
- The MXT telescope (Microchannel X-ray Telescope) for the observation of gamma-ray bursts in the soft X-ray range (0.2 to 10 keV).
- GRM to measure the spectrum of high-energy bursts (from 15 keV to 5,000 keV).
- The VT telescope (Visible Telescope) operating in the visible range to detect and observe the visible emission produced immediately after a gamma-ray burst.

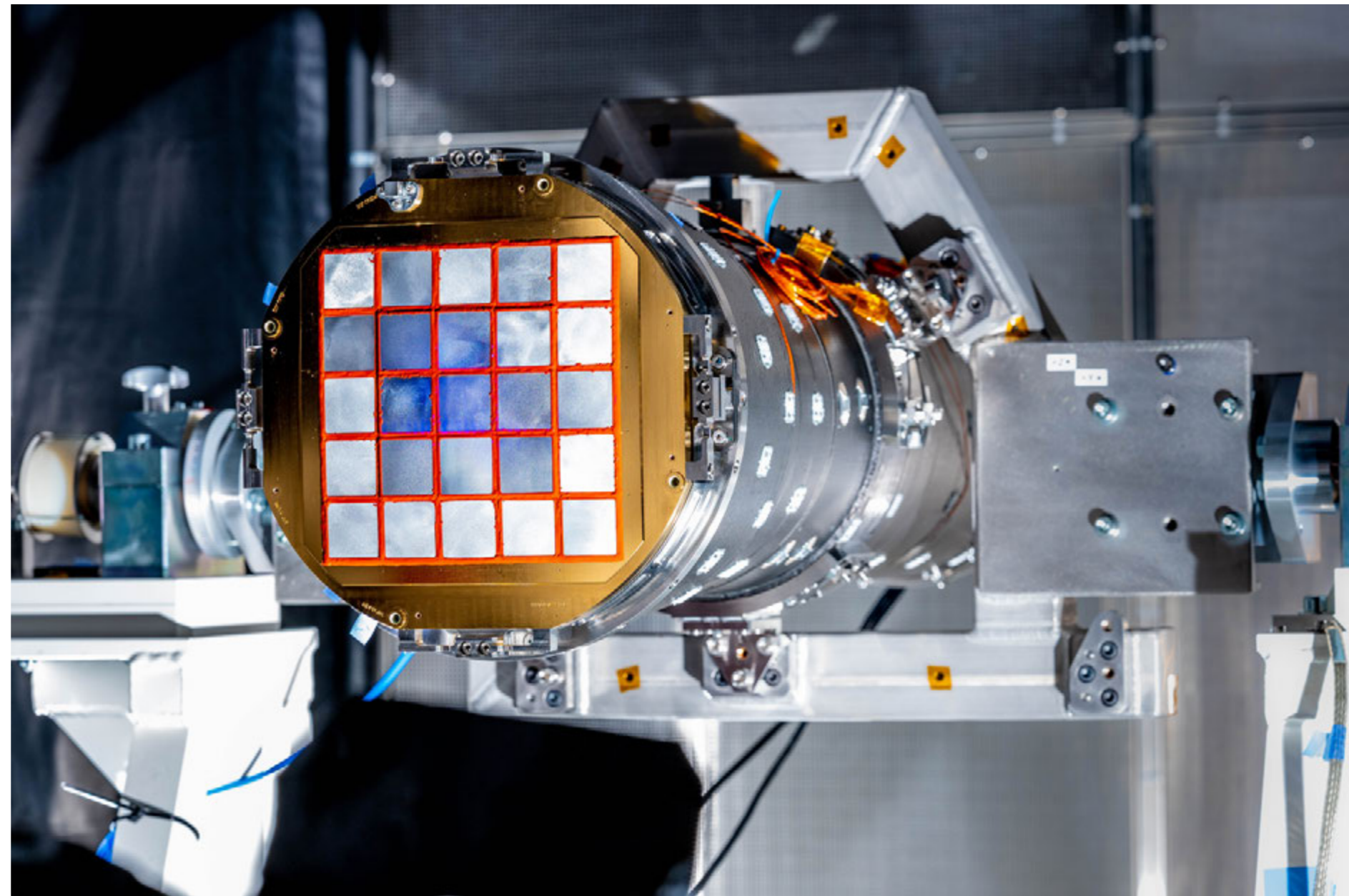

The SVOM satellite's MXT telescope.
© CNES/Thierry de Prada, 2021

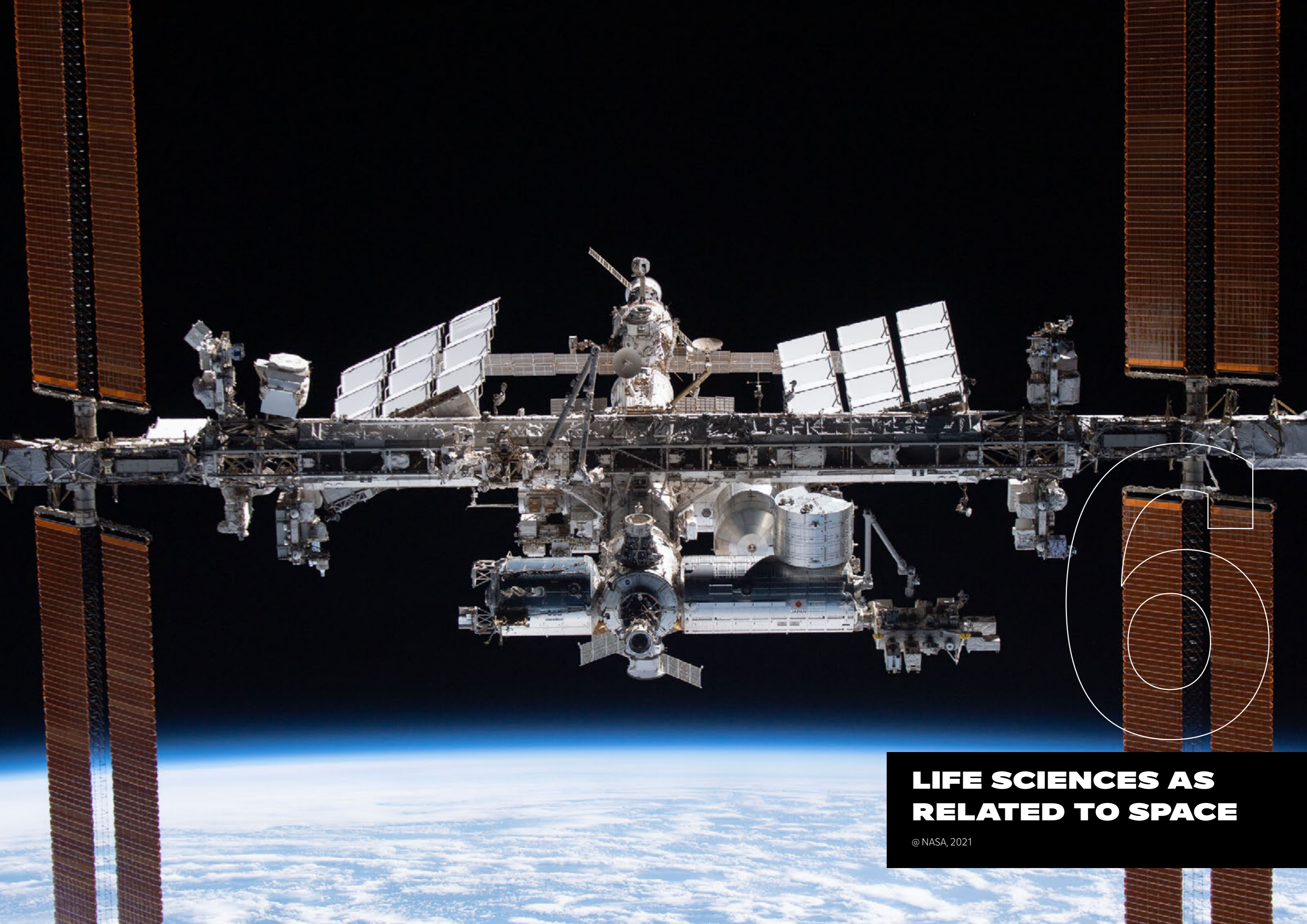

LIFE SCIENCES AS RELATED TO SPACE

@ NASA, 2021



[Author: G.GAUQUELIN KOCH]
Head of Life Sciences

6 LIFE SCIENCES AS RELATED TO SPACE

Humans have always explored, exploited, colonized and controlled their environment by expanding their field of activity. From the very first hominids, technological progress has exposed our species to extreme situations and hostile environments. But although humankind's expansion into space seems irreversible, it is still a major challenge for humans. Indeed, gravity has shaped the plant and animal world over millions of years, and we spend much of our lives resisting it.

Human bioastronautics programmes have grown out of the culmination of 50 years of human spaceflight experience. Medical and physiological findings from these missions have demonstrated that spaceflight has a dramatic impact on almost all physiological systems including muscle atrophy, bone demineralization, cardiovascular and metabolic dysfunctions, impaired cognitive processes and reduced immunological competence, and nutrition/metabolism. These adaptive responses lead to a physiological de-conditioning in space and have the potential to affect crew health and performance both in space and upon return to Earth.

Dry immersion campaign at the MEDES space clinic.
© CNES/Thierry de Prada, 2021



The scientific communities working on life sciences in the microgravity environment have access to a number of different existing space and ground-based facilities to conduct their experiments: the International Space Station, recoverable capsules, parabolic flights and ground simulation (bedrest, centrifuge and immersion).

[Author: G.GAUQUELIN KOCH]

Head of Life Sciences

/ BEDREST

Spaceflights have shown the possibilities of human adaptation and performance limits. "Space fog", which will receive more attention in the future, is the term encapsulating the cognitive alterations potentially felt by astronauts in addition to physiological disorders. Considering the limited number of flight opportunities, space agencies are actively engaged in studies on the ground with two approaches: -6° head-down bed rest (HDBR) and dry immersion (DI) to study the effects of microgravity.

HDBR is the most frequently used ground-based simulation for gravitational unloading of the human body. Unlike HDBR, DI provides a unique opportunity to study the physiological effects of the lack of a supporting structure for the body and creates a state akin to weightlessness called "supportlessness". Physiological changes are developed more rapidly and are more pronounced than under HDBR. CNES conducted at the MEDES space clinic (Toulouse) three-day (2015) and five-day (2019) DIs with 12 and 18 healthy male volunteers, respectively. In 2021, ESA conducted a third with 18 healthy women.



Dry immersion campaign at the MEDES space clinic.
© CNES/Thierry de Prada, 2021

REFERENCES

- Gros A, Lavenu L, Morel JL, De Deurwaerdère P. 2021 Simulated Microgravity Subtly Changes Monoamine Function across the Rat Brain. *Int J Mol Sci.* Oct 29;22(21):11759. doi: 10.3390/ijms222111759.
- Nay K, Koechlin-Ramonatxo C, Rochdi S, Island ML, Orfila L, Treffel L, Bareille MP, Beck A, Gauquelin-Koch G, Ropert M, Loréal O, Derbré F. 2020 Simulated microgravity disturbs iron metabolism and distribution in humans: Lessons from dry immersion, an innovative ground-based human model. *FASEB J.* Nov; 34(11):14920-14929. doi: 10.1096/fj.202001199RR.
- Fovet T, Guilhot C, Stevens L, Montel V, Delobel P, Roumanille R, Semporé MY, Freyssenet D, Py G, Brioché T, Chopard A. 2021 Early Deconditioning of Human Skeletal Muscles and the Effects of a Thigh Cuff Countermeasure. *Int J Mol Sci.* Nov 8;22(21):12064. doi: 10.3390/ijms222112064.
- Chomienne L, Blouin J, Bringoux L. Online corrective responses following target jump in altered gravito-inertial force field point to nested feedforward and feedback control. *2021 J Neurophysiol.* Jan 1;125(1):154-165. doi: 10.1152/jn.00268.2020.

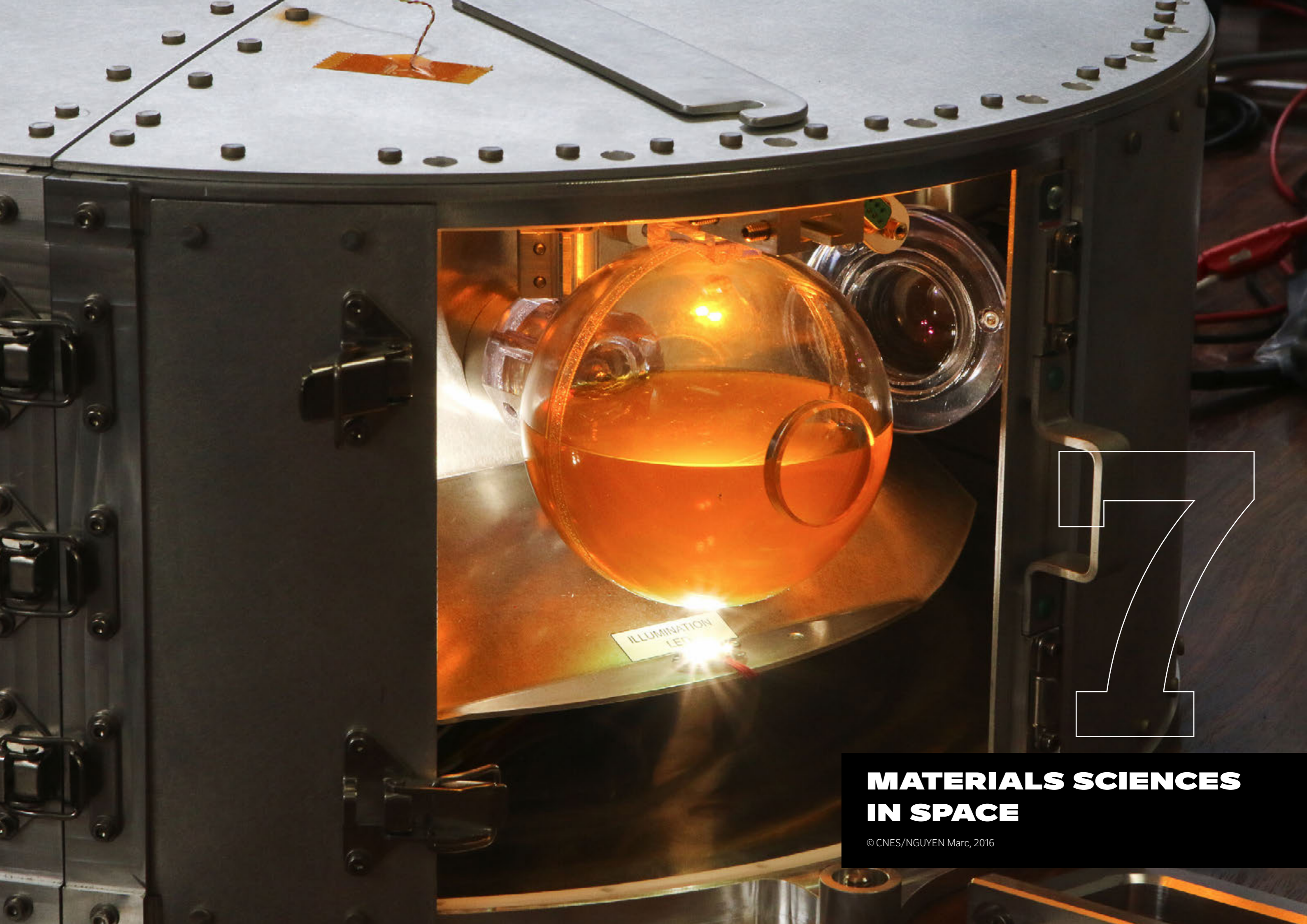

7

MATERIALS SCIENCES IN SPACE

© CNES/NGUYEN Marc, 2016

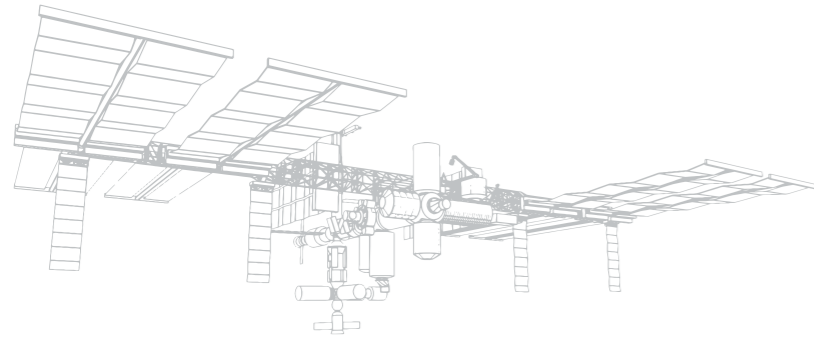

[Author: C.DELAROCHE]
Material Science Programme Manager

/ FLUIDICS

7 MATERIALS SCIENCES IN SPACE

CNES leads a programme in the field of physical sciences offering microgravity conditions to French laboratories. Most of the time we offer access to weightlessness campaigns, which provide 100 periods of 20 seconds of micro-G. When longer periods of microgravity are required, after validation of the prototype we look for international opportunities to share our knowledge and access experiments in sounding rockets or on the ISS. The general goal of physical science in microgravity is to understand the self-organization of matter during phase transitions. Microgravity on the one hand simplifies problems by removing the gravity term in the equations, and on the other hand suppresses the disturbing phenomena induced by gravity such as convection, sedimentation or buoyancy. The fields covered by CNES include fluid physics, complex materials, biophysics, solidification of matter and combustion.

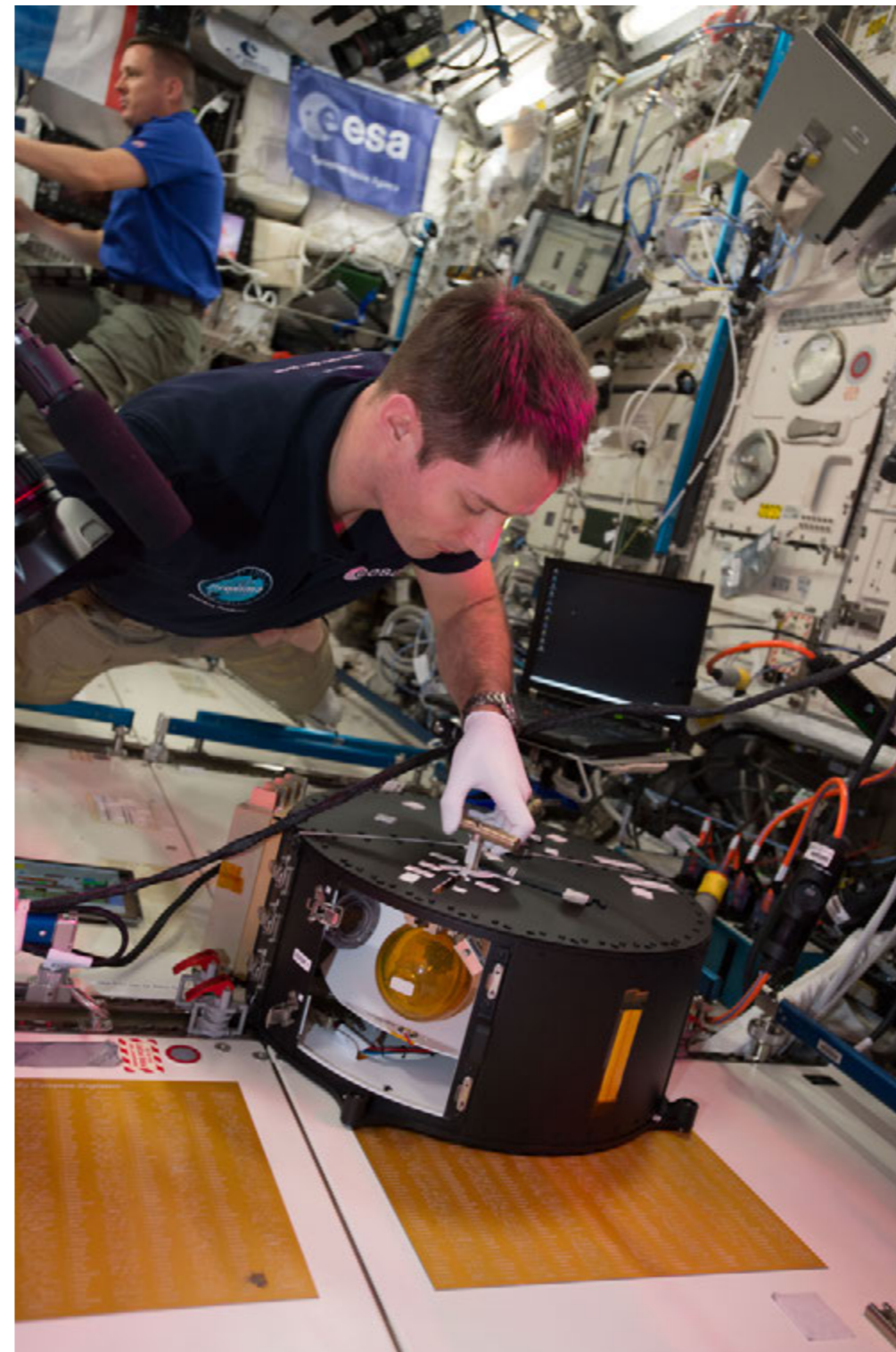

FLUIDICS is an example of an instrument developed by CNES dedicated to studying the behaviour of fluids subjected to mechanical excitation. A transparent sphere containing liquid is shaken angularly. In microgravity, the liquid spreads by capillarity over the entire surface of the sphere, thus eliminating the edge effects inevitably encountered in a test pool on the ground. Cameras and liquid film height sensors record the movements of the free surface. Installed in the ISS, the theory of capillary wave turbulence this experiment verified the theory of capillary wave turbulence for the first time. Since then, ESA has been using the instrument aboard the ISS for many European laboratories, in particular to simulate sloshing of propellants in the tanks of launchers or satellites. However, to overcome angular excitation artefacts and improve research, CNES is launching a project for a new instrument including a linear exciter for larger spheres.

FLUIDICS.
©ESA/NASA Th.Pesquet, 2021

REFERENCES

Michael Berhanu, Eric Falcon, Guillaume Michel, Christophe Gissinger, Stéphan Fauve. (2019).

Capillary wave turbulence experiments in microgravity.

EPL 128 34001. <https://iopscience.iop.org/article/10.1209/0295-5075/128/34001>.

[Author: C.DELAROCHE]
 Material Science Programme Manager

// DECLIC

DECLIC is a small physics laboratory intended for the study of transparent materials requiring high-definition imaging and precise thermal regulation. As part of a collaboration with NASA, CNES fully developed this instrument, installed by NASA on the ISS in 2009. French and American laboratories are cooperating to study fluids at the critical point and the chemistry of supercritical water as well as the solidification of transparent model materials. After a recent two-year maintenance operation, the DECLIC instrument returned to the ISS in 2021 to

conclude the current programme and prepare a new DECLIC-Evolution programme. Work on solidification will continue and we are starting to develop two new instruments to study the combustion of organic matter, mainly to purify water in space stations and to study the effects of turbulence on the nucleation of droplets of water in order to answer the questions of the IPCC on the microphysics of clouds.



ISS.
 © AdobeStock

DECLIC installation.
 © ESA/NASA Th.Pesquet, 2021

REFERENCES

DECLIC Solidification:
 F.L. Mota, J. Pereda, K. Ji, Y. Song, R. Trivedi, A. Karma, N. Bergeon. (February 2021) Effect of sub-boundaries on primary spacing dynamics during 3D directional solidification conducted on DECLIC-DSI Acta Materialia 204(3) DOI:10.1016/j.actamat.2020.116500.



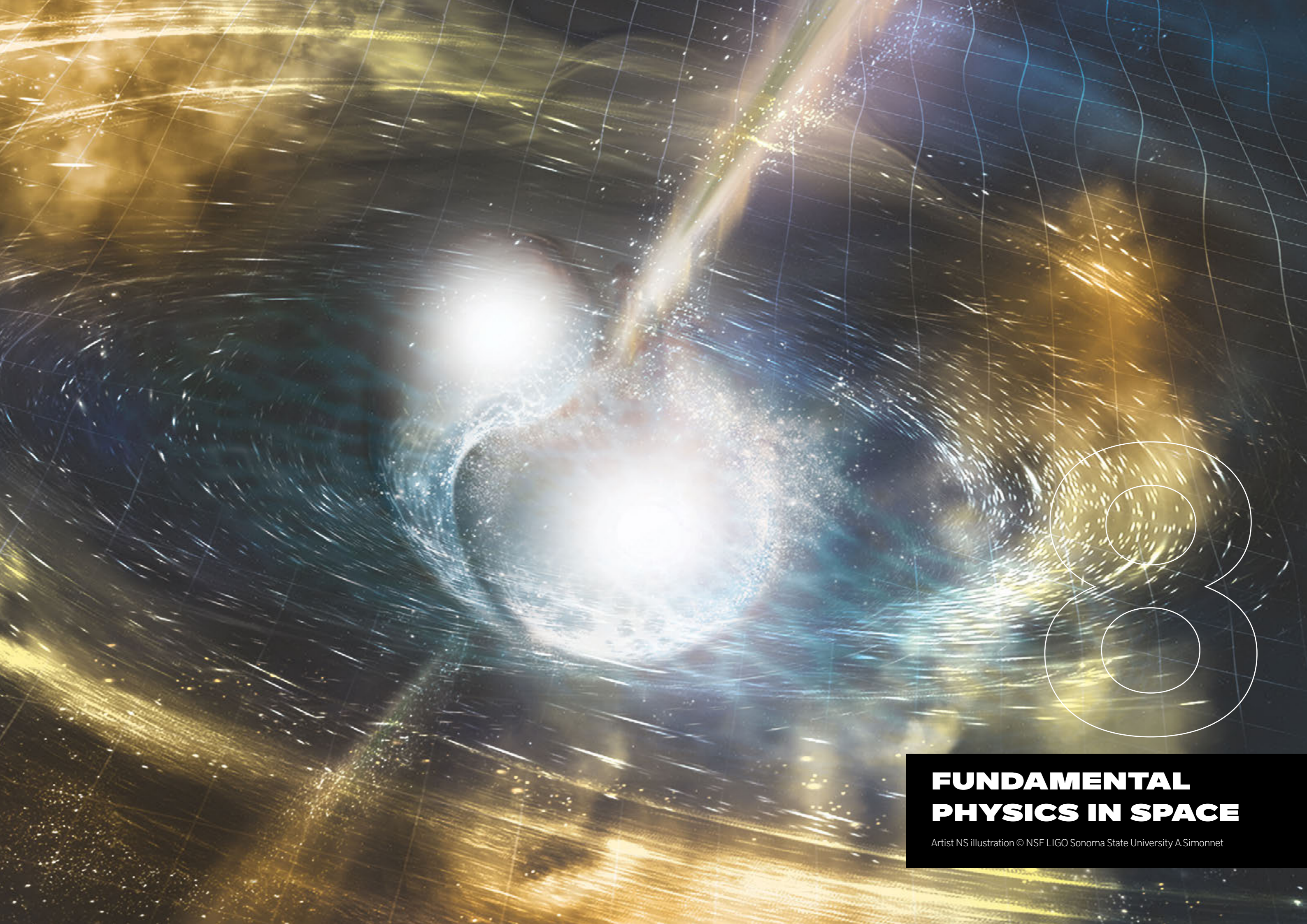

**FUNDAMENTAL
PHYSICS IN SPACE**

Artist NS illustration © NSF LIGO Sonoma State University A.Simonnet

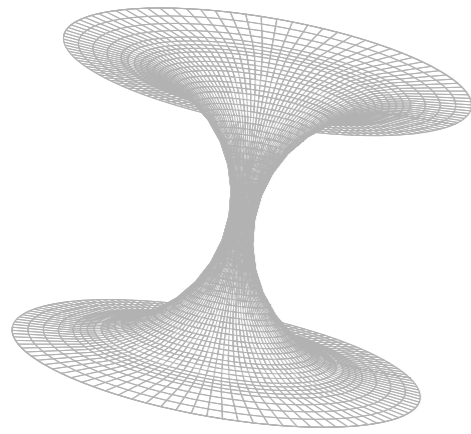

[Author: I. PETITBON]
Fundamental Physics Programme Manager

8 FUNDAMENTAL PHYSICS IN SPACE

CNES is closely involved in the activities of this commission, mainly in the area of discovering and exploring fundamental physical laws governing matter, space and time. The first results of the Microscope mission, developed by CNES and the French scientific community, with contributions from ESA, ZARM and PTB, were extensively presented in the last COSPAR report (2018) and are currently the best results on the Equivalence principle, measured with the Eötvös parameter. The final results based on all of the data should be released soon and further increase the precision.



Front Cover Image Credits:
 • Background: a composition of the centre of the Milky Way (custom composition of three different wavelengths images) and a deep star map by NASA's scientific visualization studio.
 • Earth: textures are from NASA blue marble, 3D rendering from Simon Barke.
 • LISA constellation: Simon Barke.

/ LISA

LISA is the third ESA large-class science mission dedicated to the gravitational universe, greatly enlarging the window opened by LIGO – VIRGO and paving the way to a new physics. Gravitational waves can probe the early stages of the universe, before decoupling of light and matter and emission of the microwave background.

The LISA space observatory will operate at low frequencies, from 10^{-1} to 10^{-4} Hz, and observe the whole sky as gravitational waves do not suffer from obscuration. It will be able to detect and study massive objects such as massive black holes or in-spirals of stellar mass objects, thus testing the space-time properties in the strong curvature regime.

The LISA space system is a constellation of three identical satellites trailing the Earth, about 50 million kilometres behind it. The three satellites form an equilateral triangle, the length of each arm is 2.5 million kilometres, and a giant optical interferometer. The satellites are linked in pairs by identical

and synchronized laser beams to measure any relative movements between free-fall test masses inside each instrument. These test masses are in an environment isolated from external disturbances (solar wind, parasitic forces) in order to detect infinitesimal distortions in space-time. The expected level of sensitivity is a few picometres .

A scientific consortium, including European and American scientists—with NASA as a junior partner of the mission—is contributing to the development of several on-board subsystems, data processing and, of course, science. French contributions cover coordination of and participation in the development of the distributed data processing centre and close involvement in performance verification, developing an Optical Test System (OTD) to be used at instrument level, and preparing and conducting performance tests of on the Interferometric Detection System (IDS).

LISA is currently in phase B. Adoption of the mission is foreseen in early 2024

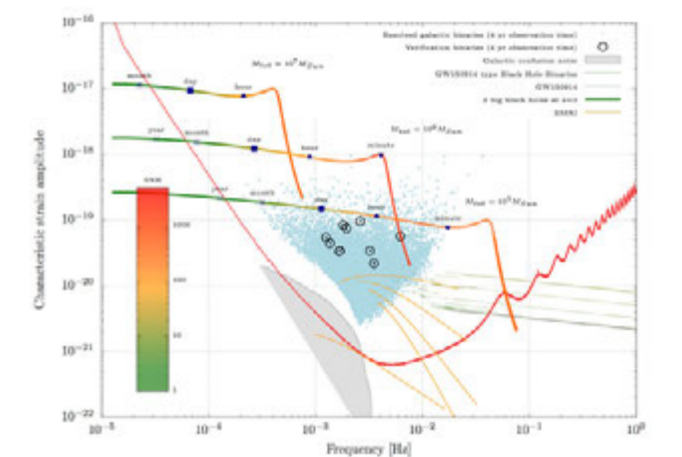
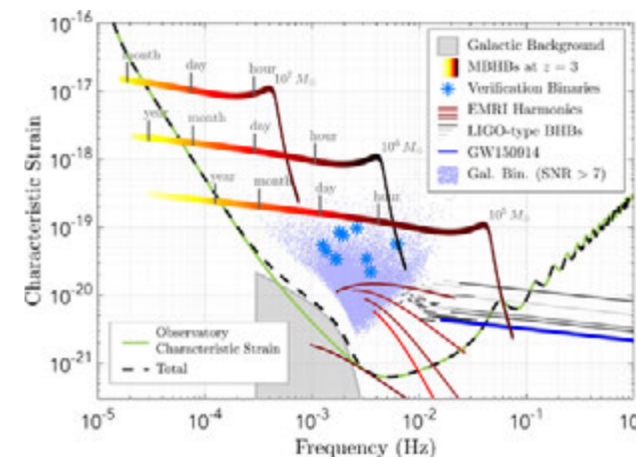

LISA sensitivity curve.

Finally, let us note that this report is in a new format compared to previous ones. We have decided to consider the current COSPAR scientific structure and for each commission to briefly underline the main achievements in which CNES has been involved. We would like to take the opportunity to thank the Heads of CNES programmes involved in producing this report. We thank Karine Priselkow, Orianne Arnould and Michele Dupire for their assistance in editing it in its new format.



Science Survey Seminar (8-10 October 2019, Le Havre).

EDITING & PROOFREADING

Boyd Vincent

ICONOGRAPHY

Photon Laboratory:

Marie-Claire Fontebasso

Orianne Arnould

DESIGN

Graphics and layout:

Karine Priselkow (Studio Ogham)

PRINTING

Pole Impression



Centre national d'études spatiales

2 place Maurice Quentin
75039 Paris cedex 01 - France
Tél. : +33 (0)1 44 76 75 00

cnes.fr

